

HINGE DOOR
INSTALLATION GUIDE
INSTRUCTIONS DE MONTAGE
GUIDA ALL'INSTALLAZIONE

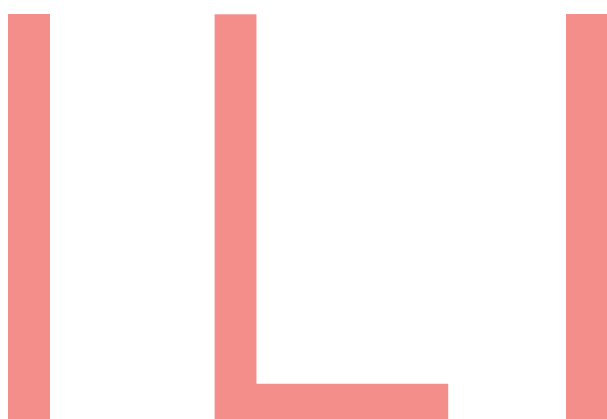

flair
—

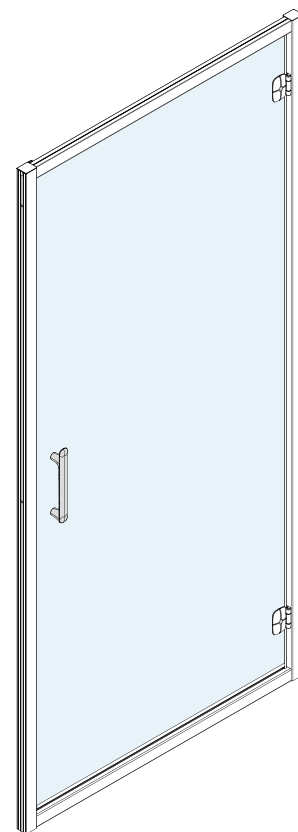

SINCE
1952

flair
—



**Thank you for purchasing your ILI
shower door from Flair Showers Ltd.**

We wish you many years of enjoyment using it.
The ILI range offers craftsmanship you can feel
and reliability you can count on.

Your bathroom is a personal affair - we hope
that your ILI shower door brings a new sense
of enrichment and enjoyment to your life.

The perfect blend of function and form –
Designed for Life.



QUALITY GUARANTEED

At Flair we have an unwavering commitment to product quality.

ILI shower doors are covered by a lifetime guarantee against manufacturer defect. This guarantee is valid on the condition that goods are installed and maintained in accordance with the products fitting instructions and best practices.

Non glass and detachable parts such as rollers, seals etc. are subject to normal wear and tear during usage and are under guarantee for 12 months from time of purchase.

Please complete your product guarantee card included in the components box or register online at flairshowers.com/register.

All Flair products are CE/UKCA approved. All glass is toughened safety glass and produced to EN12150. Flair products are performance tested to EN14428, ensuring the highest industry criteria is met.

AFTERSALES & SPARE PARTS SERVICE

Flair is 100% committed to customer service excellence.

We carry a full range of spare parts for each of our product ranges and have dedicated aftersales representatives to deal with any issues you may have.

If you would like to talk to our customer aftercare team, please contact us on 042 966 8000.

WARNING!

BEFORE YOU INSTALL YOUR SHOWER DOOR PLEASE READ ALL INSTRUCTION FAILURE TO DO SO MAY LEAD TO INVALIDATION OF YOUR WARRANTY.

Check that your product size is compatible to the installation site.
Ensure the tray is 100% level.
Check all components
Check installation kit is complete and matches the "In the box section" of this instruction.

IN THE BOX

TAKE A MINUTE TO CHECK THE CONTENTS OF EACH BOX

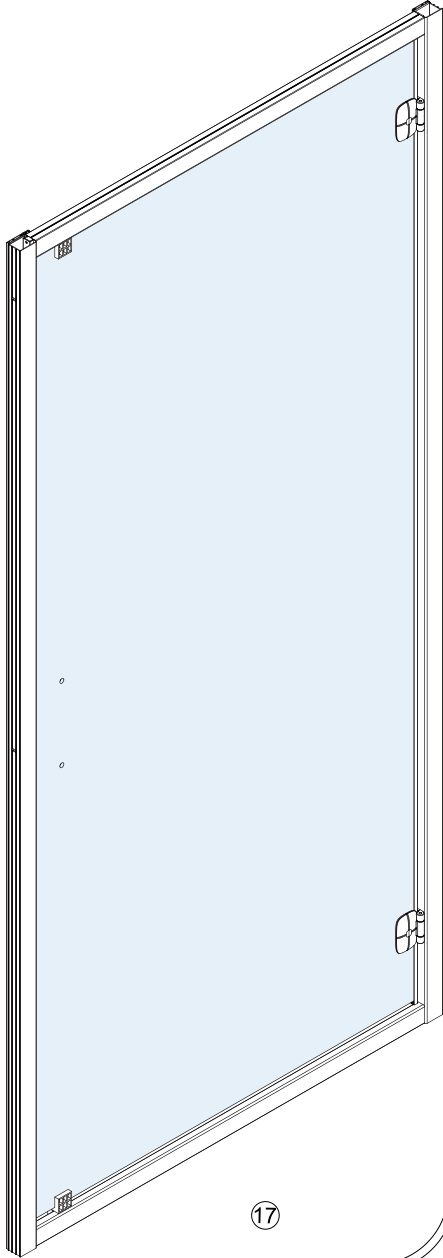

⑩

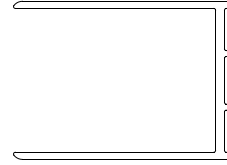

L=1948.5mm
S-ILIWJS
ILI Wall Profile x 2

⑪



L=1950mm
S-ILICS
Aluminium Cover Strip x 2

⑬&⑭

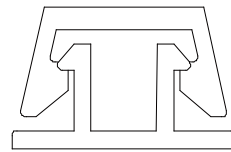

SECH91 & ALFV35
Aluminium Snap Strip

⑯

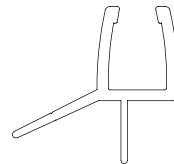

S-ILIH D
Bottom Seal x1

⑰

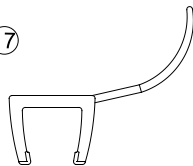

L=1877mm
S-ILIH DHGEDS
Vertical Seal x1

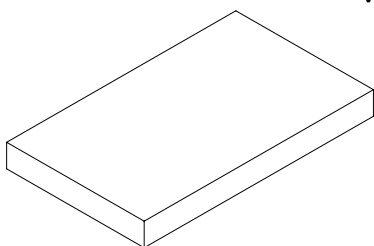

Component Pack

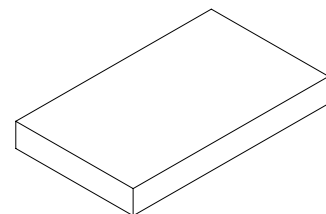

Handle Box

COMPONENTS AND TOOLS

WHAT'S IN YOUR COMPONENT PACK AND THE TOOLS YOU WILL NEED ON HAND TO FIT YOUR ILI SHOWER DOOR



Out of the Box

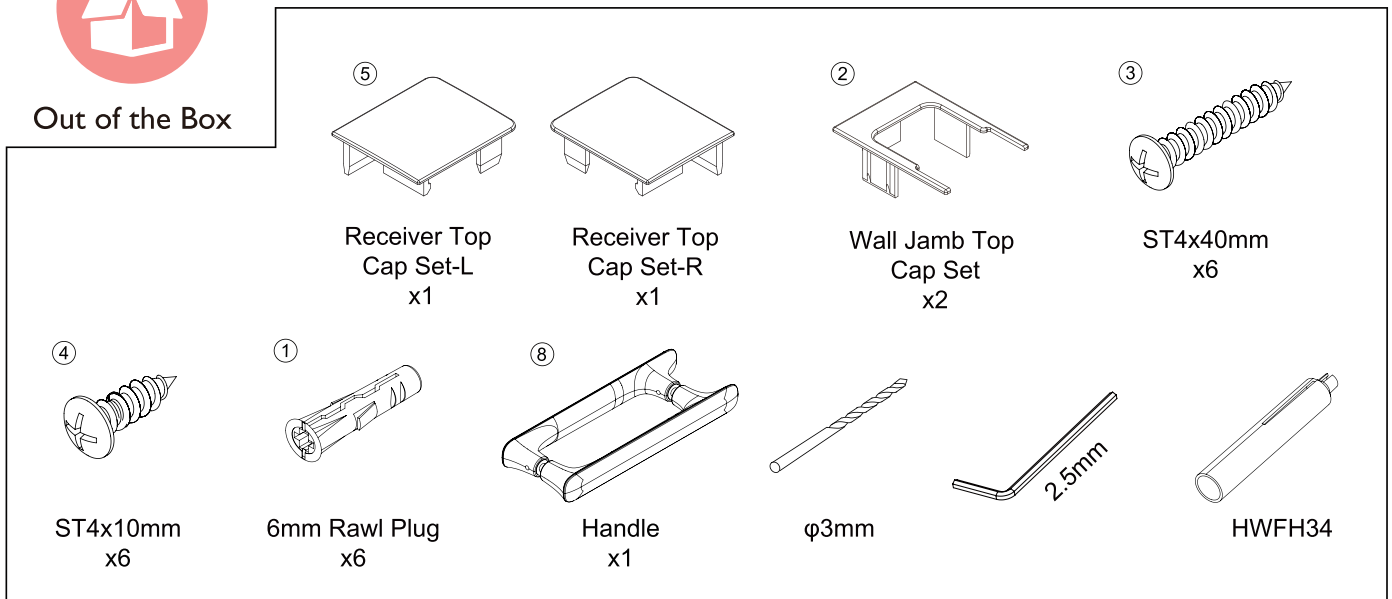

Tool Kit

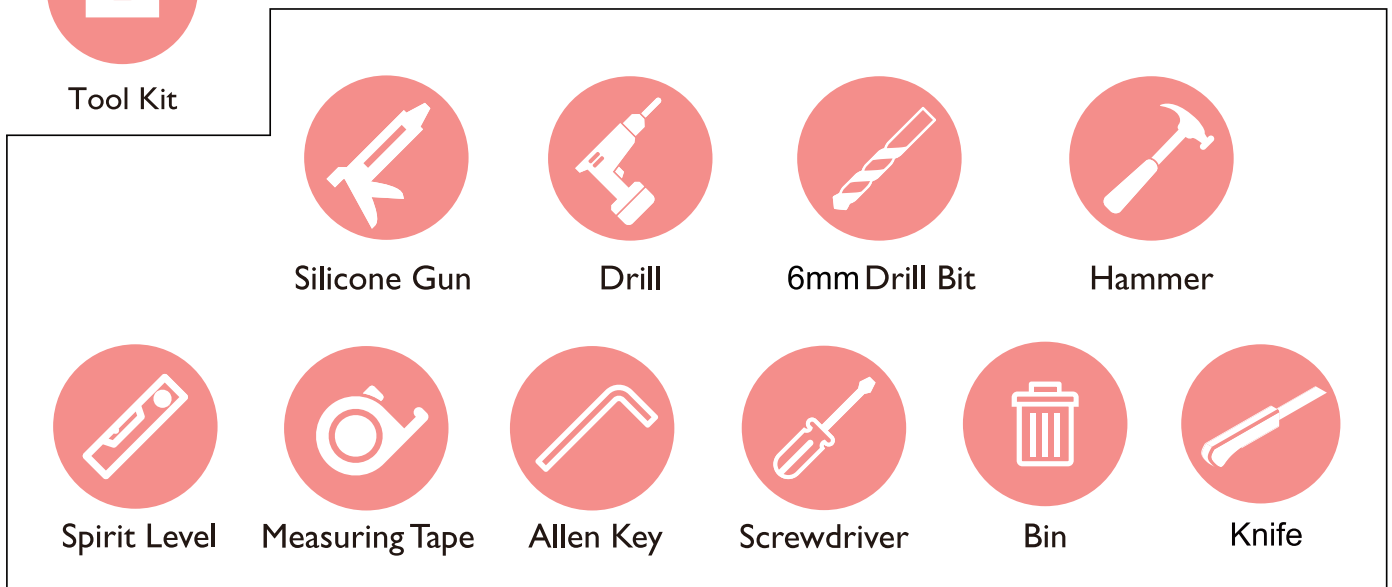

MEET THE ILI HINGE DOOR

ALL PARTS SHOWN BELOW ARE FOR ASSEMBLY

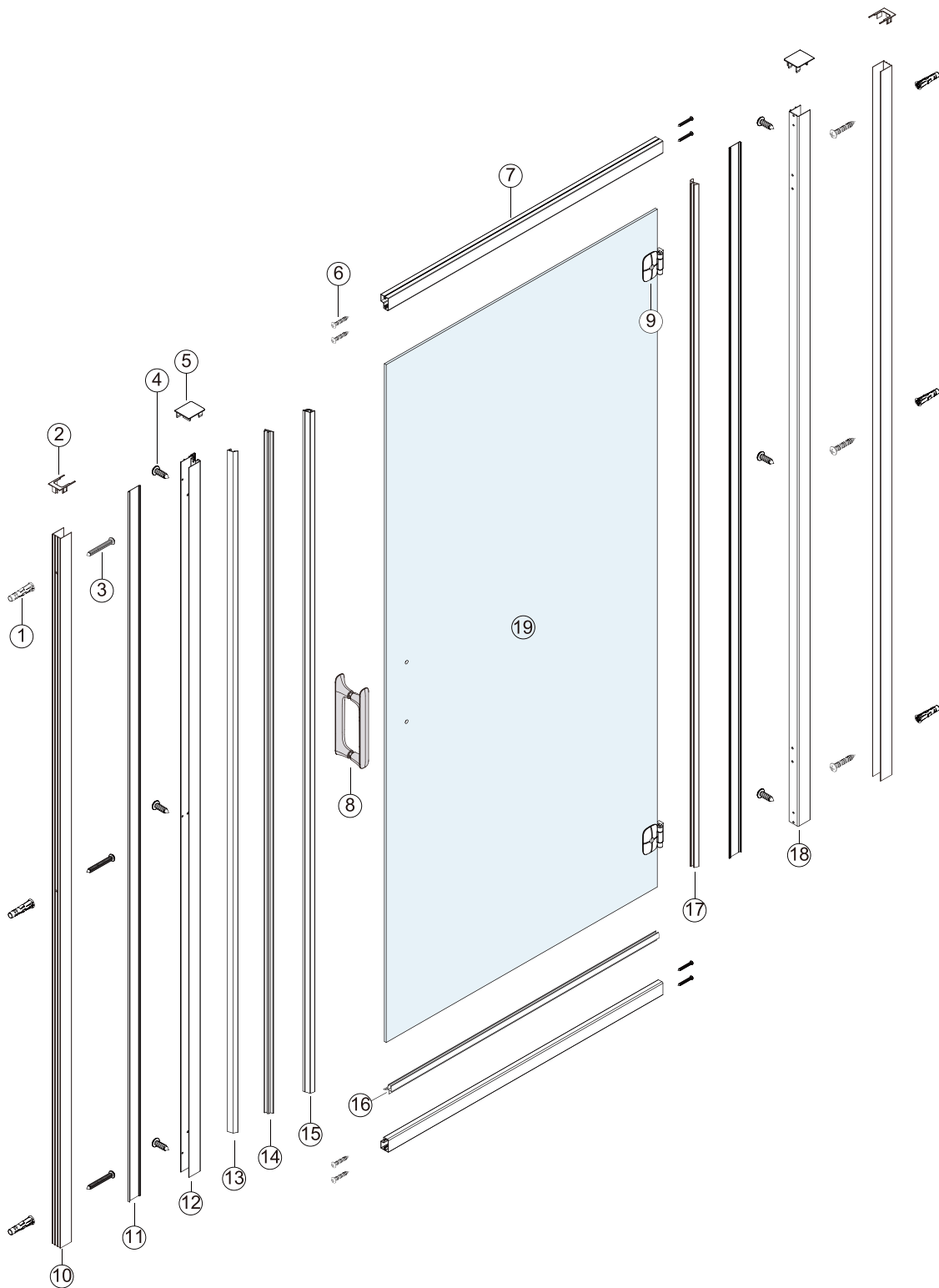

Article No.	Qty	Description	Part No.	Article No.	Qty	Description	Part No.	Article No.	Qty	Description	Part No.
①	6	6mm Rawl Plug	S-ILISP	⑧	1	Handle	S-ILIHLES	⑮	1	Magnetic Seal	S-ILHDGMS
②	2	Wall Jamb Top Cap Set	S-ILIWJCS	⑨	2	Hinge	HG042A	⑯	1	Bottom Seal	S-ILILD
③	6	ST4x40mm Screw	S-ILISP	⑩	2	Wall Profile	S-ILIWJS	⑰	1	Vertical Seal	S-ILIHGEDS
④	6	ST4x10mm Screw	S-ILISP	⑪	2	Aluminium Cover Strip	S-ILICS	⑱	1	Receiver Profile A	ALFH14
⑤	1+1	Receiver Top Cap Set	S-ILIRTCS	⑫	1	Receiver Profile B	ALFH15	⑲	1	Door Glass	A
⑥	8	ST4x30mm Screw	S-ILISP	⑬	1	Vertical Snap Seal	SECH91				
⑦	2	Rails	ALFH71	⑭	1	Aluminium Snap Strip	ALFV35				

ILI

FR

**Merci d'avoir choisi votre porte de douche
ILI chez Flair Showers Ltd.**

Nous espérons que vous apprécierez ce produit pendant de nombreuses années. Notre gamme ILI offre un savoir-faire remarquable et une fiabilité sur laquelle vous pouvez compter.

Votre salle de bain est un lieu de relaxation personnel, avec ILI nous espérons que votre douche apporte satisfaction et plaisir dans votre vie.

La combinaison parfaite de la fonctionnalité et du style - DESIGNED FOR LIFE.

GARANTIE DE QUALITÉ

Chez Flair, nous avons un engagement indéfectible à la qualité des produits.

Les portes de douche ILLI sont couvertes par une garantie à vie contre tous les défauts de fabrication. Cette garantie est valable à condition que les produits soient installés et entretenus en accord avec les instructions recommandées par FLAIR.

Les parties non en verre et amovibles telles que les joints etc. sont soumises à usure normale durant leur usage et sont garanties 12 mois à compter de la date d'achat.

Tous les produits Flair sont certifiés CE/UKCA, avec un verre de sécurité trempé, selon la norme EN12150. Les produits Flair sont soumis à des tests de performance selon la norme EN 14428, garantissant le respect des critères les plus élevés de l'industrie.

SERVICE APRÈS VENTE ET PIÈCES DÉTACHÉES

Flair est engagé à 100% au service de sa clientèle.

Nous disposons d'un stock complet de pièces détachées pour chacun de nos produits et nos techniciens du service après-vente peuvent étudier tout problème éventuel.

Veuillez nous contacter par téléphone au +353 42 969 4436 ou par email à ventes@flairshowers.com.

ATTENTION:
AVANT D'INSTALLER VOTRE PORTE DE DOUCHE, LIRE ATTENTIVEMENT TOUTES LES INSTRUCTIONS. LE NON RESPECT DE CETTE CONSIGNE ANNULERA LA GARANTIE DE VOTRE PRODUIT.

Vérifiez tous les composants. Vérifiez que le kit d'installation soit complet et corresponde à la section "DANS LE CARTON" de ces instructions.

DANS LE CARTON

MERCI DE PRENDRE LE TEMPS DE VÉRIFIER
LE CONTENU DE CHAQUE BOÎTE

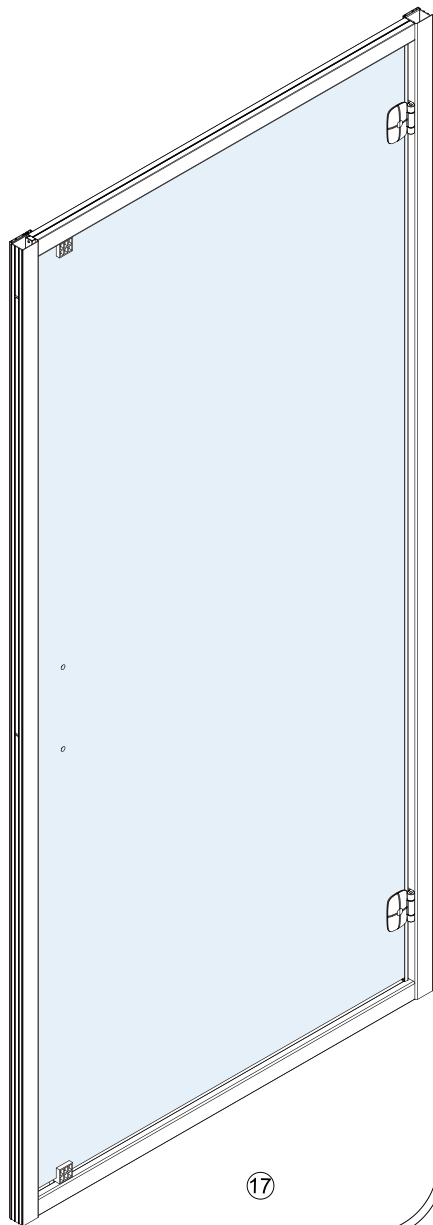

⑩

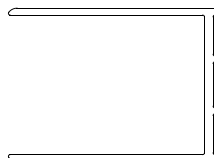

L=1948.5mm
S-ILIWJS
Profilé Murax x 2

⑪



L=1950mm
S-ILICS
Cache vis Profilé aluminium x 2

⑬&⑭

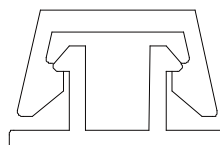

SECH91 & ALFV35
Profilé Cache vis
en aluminium

⑯

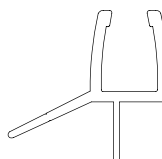

S-ILIHG
Cache vis
charnière x1

⑰

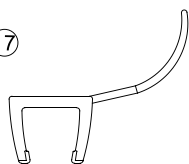

L=1877mm
S-ILIHGEGDS
Joint Vertical x1

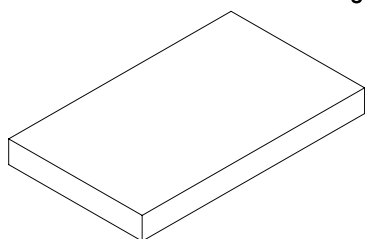

Boîte de composants/ Kit d'outils

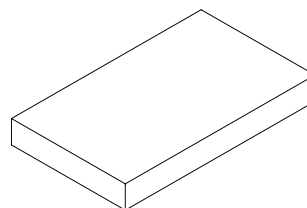

Boîte de poignées

COMPOSANTS ET OUTILS

LES ARTICLES QUE VOUS TROUVEREZ DANS LE KIT DE COMPOSANTS ET LES OUTILS NÉCESSAIRES À INSTALLER VOTRE PORTE DE DOUCHE ILI.



Dans la boîte

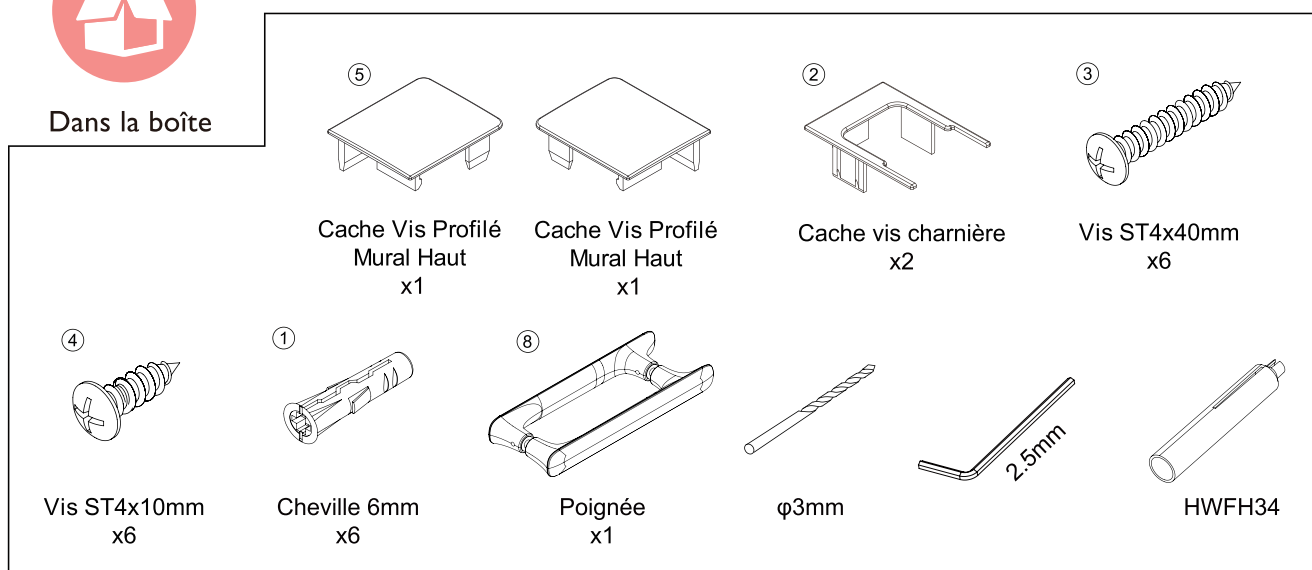

Kit d'outils

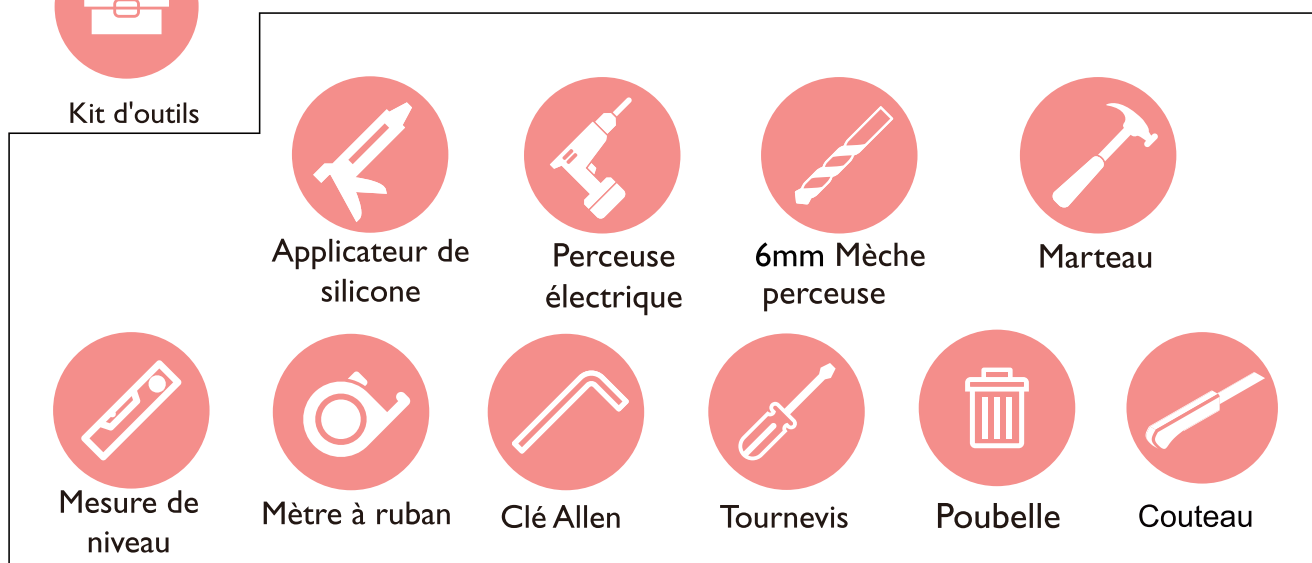

PORTE PIVOTANTE ILI

TOUTES LES PIÈCES PRÉSENTÉES CI-DESSOUS SONT NÉCESSAIRES POUR ASSEMBLER LE PRODUIT.

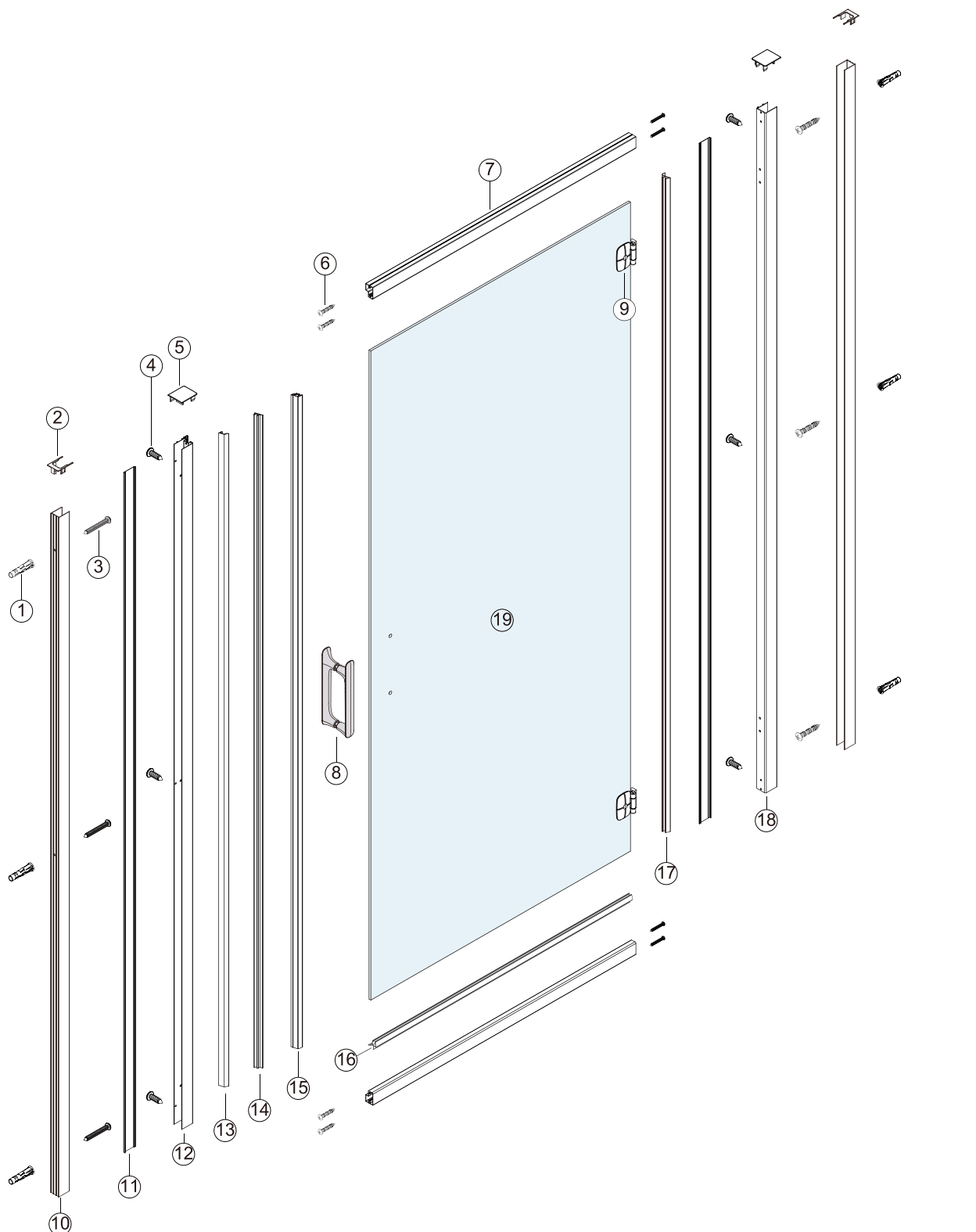

ARTICLE No.	QTE	Description	Pièce	ARTICLE No.	QTE	Description	Pièce	ARTICLE No.	QTE	Description	Pièce
(1)	6	Cheilles 6mm	S-ILISP	(8)	1	Poignée	S-ILIHLES	(15)	1	Joint magnétique	S-ILIHGMS
(2)	2	Cache Vis Profilé Mural Haut	S-ILIWJCS	(9)	2	Charnière	HG042A	(16)	1	Joint Bas	S-ILIID
(3)	6	Vis ST4x40mm	S-ILISP	(10)	2	Profilé Mural	S-ILIWJS	(17)	1	Joint Vertical	S-ILIDHGEDS
(4)	6	Vis ST4x10mm	S-ILISP	(11)	2	Cache vis Profilé aluminium	S-ILICS	(18)	1	Profilé Recepteur A	ALFH14
(5)	1+1	Cache Vis Profilé Mural Haut	S-ILIRTCS	(12)	1	Profilé Recepteur B	ALFH15	(19)	1	Panneau en Verre	A
(6)	8	Vis ST4x30mm	S-ILISP	(13)	1	Joint vertical	SECH91				
(7)	2	Rails	ALFH71	(14)	1	Profilé Cache vis en aluminium	ALFV35				

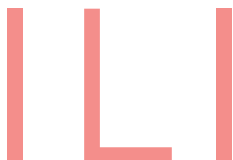

**Vi ringraziamo per aver scelto la porta
doccia ILLI di Flair Showers Ltd.**

Siamo certi che nel suo utilizzo, ora e per molti
anni a venire, avrete modo di apprezzarne la
qualità artigianale e l'affidabilità.

Il bagno è lo spazio in cui inizia e termina la
giornata - la porta doccia ILLI renderà questi
momenti più piacevoli.

ILLI è il perfetto mix tra design e funzionalità -
progettato per la vita.



GARANZIA DI QUALITÀ

Flair si impegna costantemente per offrire prodotti di qualità.

I prodotti ILLI sono coperti da una garanzia a vita per difetti di fabbrica. La garanzia sarà valida a condizione che il prodotto venga installato e mantenuto nel rispetto delle istruzioni di montaggio di Flair e del buon senso.

Le parti soggette ad usura come le guarnizioni, i cuscinetti, etc. sono coperte da garanzia per 12 mesi dalla data d'acquisto.

Siete pregati di compilare il certificato di garanzia incluso nell'imballaggio o di registrare il vostro prodotto sul sito: flairshowers.com/it/registrazione-della-garanzia-prodotto.

Tutti i prodotti Flair sono conformi alla normativa CE/UKCA. Il vetro viene temperato e prodotto secondo le norme EN12150. Inoltre, tutti i prodotti sono testati e certificati EN14428, assicurandone i massimi standard qualitativi.

SERVIZIO POST VENDITA

Flair si impegna nell'offrirti un eccellente servizio customer care.

Forniamo una gamma completa di pezzi di ricambio per ogni nostra collezione e mettiamo a disposizione specialisti post-vendita per assistervi con eventuali problemi.

Contatta il servizio clienti al +39 0287368301 oppure assistenzaclienti@flairshowers.com

AVVERTENZA!

**PRIMA DELL'INSTALLAZIONE
LEGGERE ATTENTAMENTE LE
ISTRUZIONI DI MONTAGGIO.
LA MANCATA OSSERVANZA
DELLE ISTRUZIONI POTREBBE
INVALIDARE LA GARANZIA.**

Verificare che le misure del prodotto siano compatibili con quelle dell'area di installazione.
Assicurarsi che il piatto doccia sia 100% in bolla.
Controllare tutte le parti.

CONTENUTO IMBALLAGGIO

TI PREGHIAMO DI CONTROLLARE IL CONTENUTO
DI CIASCUNA SCATOLA.

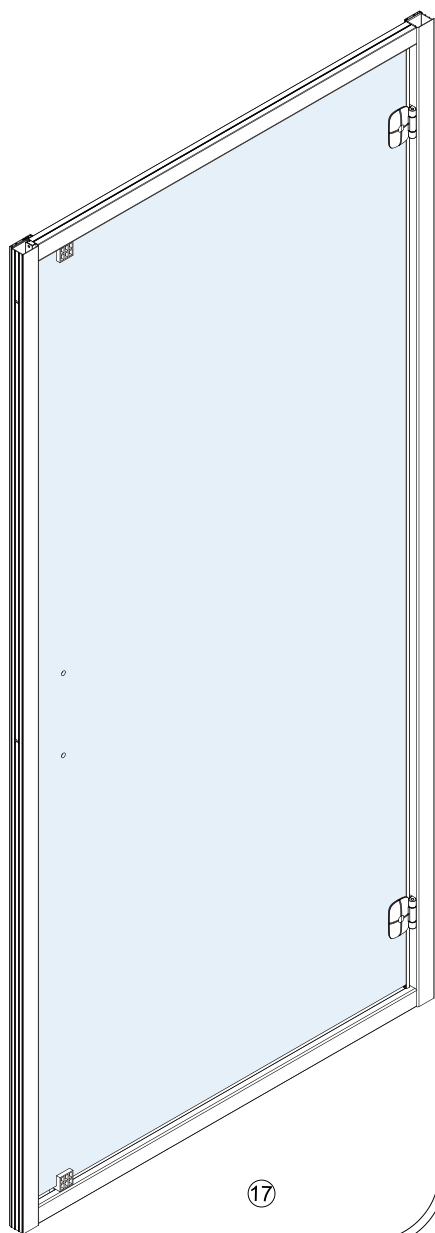

⑩

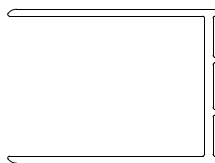

L=1948.5mm
S-ILIWJS
Profilo a Muro x 2

⑪



L=1950mm
S-ILICS
Copri viti x 2

⑬&⑭

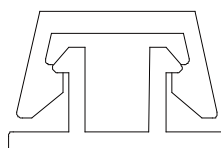

SECH91 & ALFV35
Profilo a incastro e guarnizione

⑰

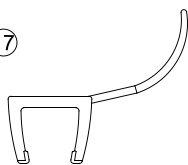

L=1877mm
S-ILIHGEDS
Guarnizione Verticale x1

⑰

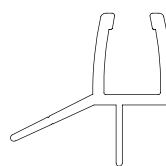

S-ILIH
Guarnizione
inferiore x1

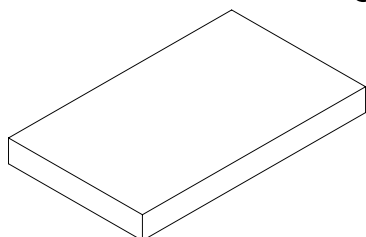

Kit di montaggio

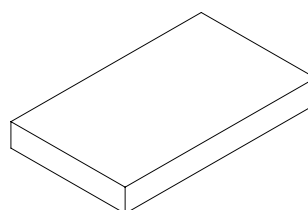

Imballaggio Maniglia

STRUMENTI PER L'INSTALLAZIONE

CONTENUTO DEL KIT DI MONTAGGIO E GLI STRUMENTI RICHIESTI



Nella scatola

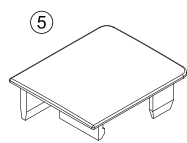

Copri profilo - sx
x1

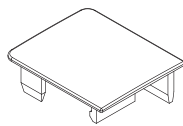

Copri profilo - dx
x1

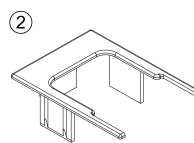

Copri profilo a muro
x2

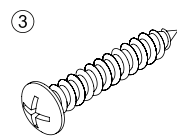

Viti 4x40mm
x6

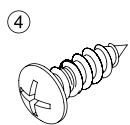

Viti 4x10mm
x6

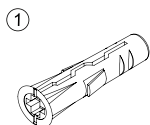

6mm Tassello
x6

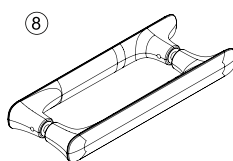

Maniglia
x1

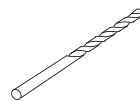

φ3mm

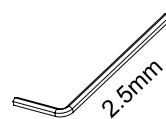

2.5mm

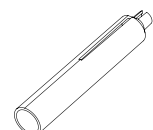

HWFH34



Strumenti



Pistola per
silicone



Trapano



6mm Punta
da trapano



Martello



Bolla



Metro a nastro



Brugola



Cacciavite



Cestino



Taglierino

FLAIR PRESENTA LA PORTA A BATTENTE ILI

TUTTE LE COMPONENTI NECESSARIE PER L'ASSEMBLAGGIO

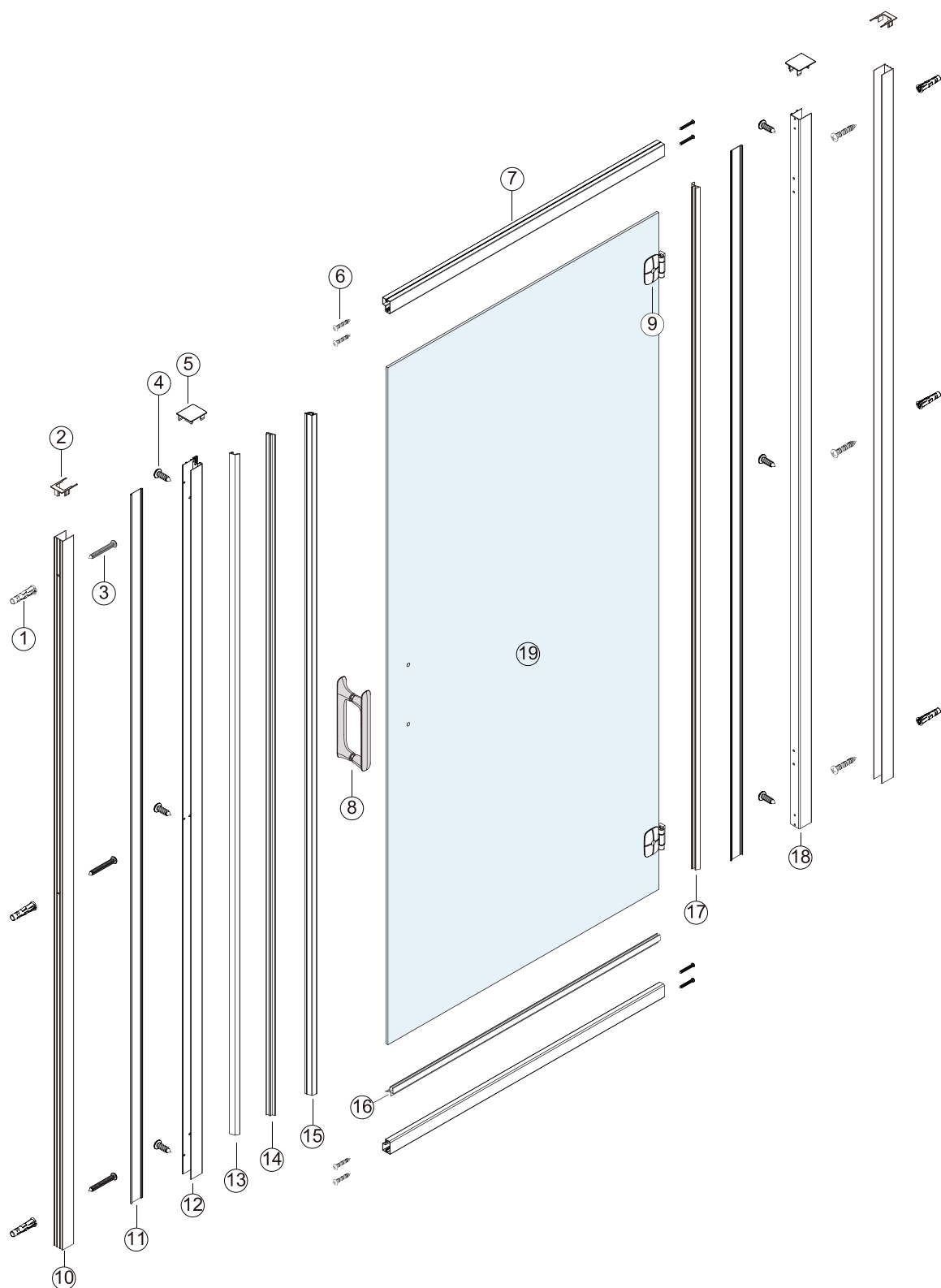

Nr Articolo	Qtà	Descrizione	Codice	Nr Articolo	Qtà	Descrizione	Codice	Nr Articolo	Qtà	Descrizione	Codice
(1)	6	Tassello 6mm	S-ILISP	(8)	1	Maniglia	S-ILIHLES	(15)	1	Guarnizione Magnetica	S-ILIHGMS
(2)	2	Copri Profilo a muro	S-ILIWJCS	(9)	2	Cerniera	HG042A	(16)	1	Guarnizione inferiore	S-ILIH
(3)	6	Viti 4x40mm	S-ILISP	(10)	2	Profilo a Muro	S-ILIWJS	(17)	1	Guarnizione Verticale	S-ILIHGEDS
(4)	6	Viti 4x10mm	S-ILISP	(11)	2	Copri Viti	S-ILICS	(18)	1	Profilo	ALFH14
(5)	1+1	Copri profilo	S-ILIRTCS	(12)	1	Profilo	ALFH15	(19)	1	Porta	A
(6)	8	Viti 4x30mm	S-ILISP	(13)	1	Guarnizione per profilo a incastro	SECH91				
(7)	2	Binari guida	ALFH71	(14)	1	Profilo a incastro in Alluminio	ALFV35				

1

Attention:

If fitting this door with a side panel, please read the side panel fitting instruction first.

Si vous installez cette porte de douche avec un panneau latéral, lisez d'abord les instructions de montage du panneau latéral.

In caso di installazione lato fisso, vedi istruzioni di montaggio lato fisso.

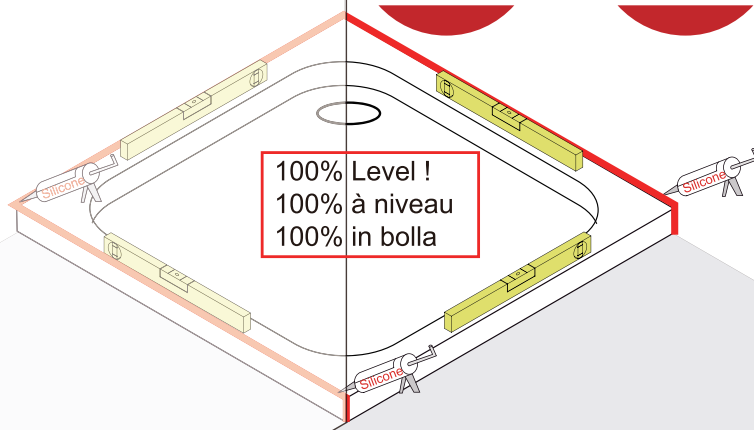

2

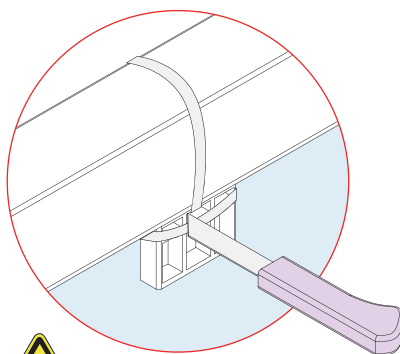
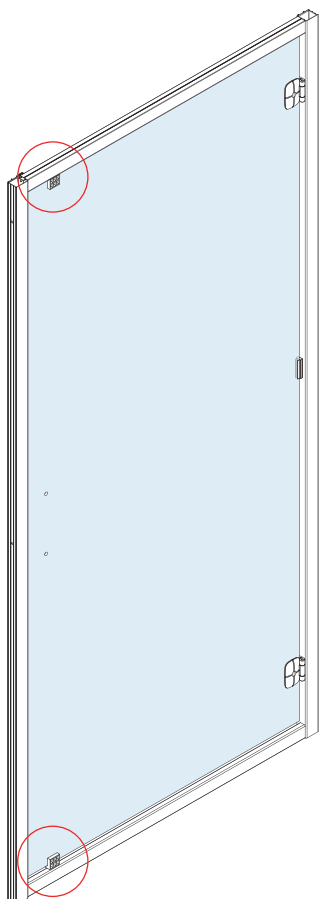

CAUTION SHARP ELEMENT
WARNING:
Please take adequate care in removing this cable tie so not to cause injury.

FARE ATTENZIONE DURANTE L'UTILIZZO DI STRUMENTI DA TAGLIO:

Si prega di prestare particolare attenzione durante la rimozione delle fascette al fine di evitare lesioni.



3

inside
à l'intérieur
all'interno

- 1
- 2
- 3

6mm

Wall jamb of door closing side
Profilé mural - côté fermeture de la porte
Profilo a muro - lato chiusura porta

inside
à l'intérieur
all'interno

- 1
- 2
- 3
- 4

6mm

ST4x40mm

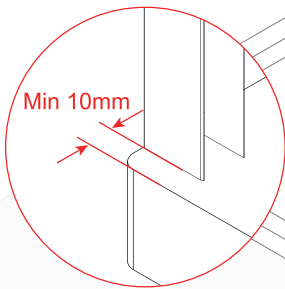

Size Taille Dimensione	X
760	710-760
800	750-800
900	850-900
1000	950-1000



4

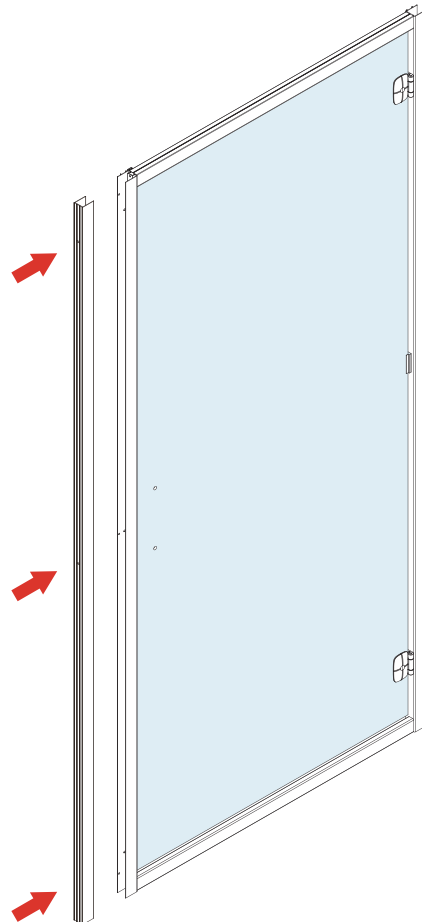

5

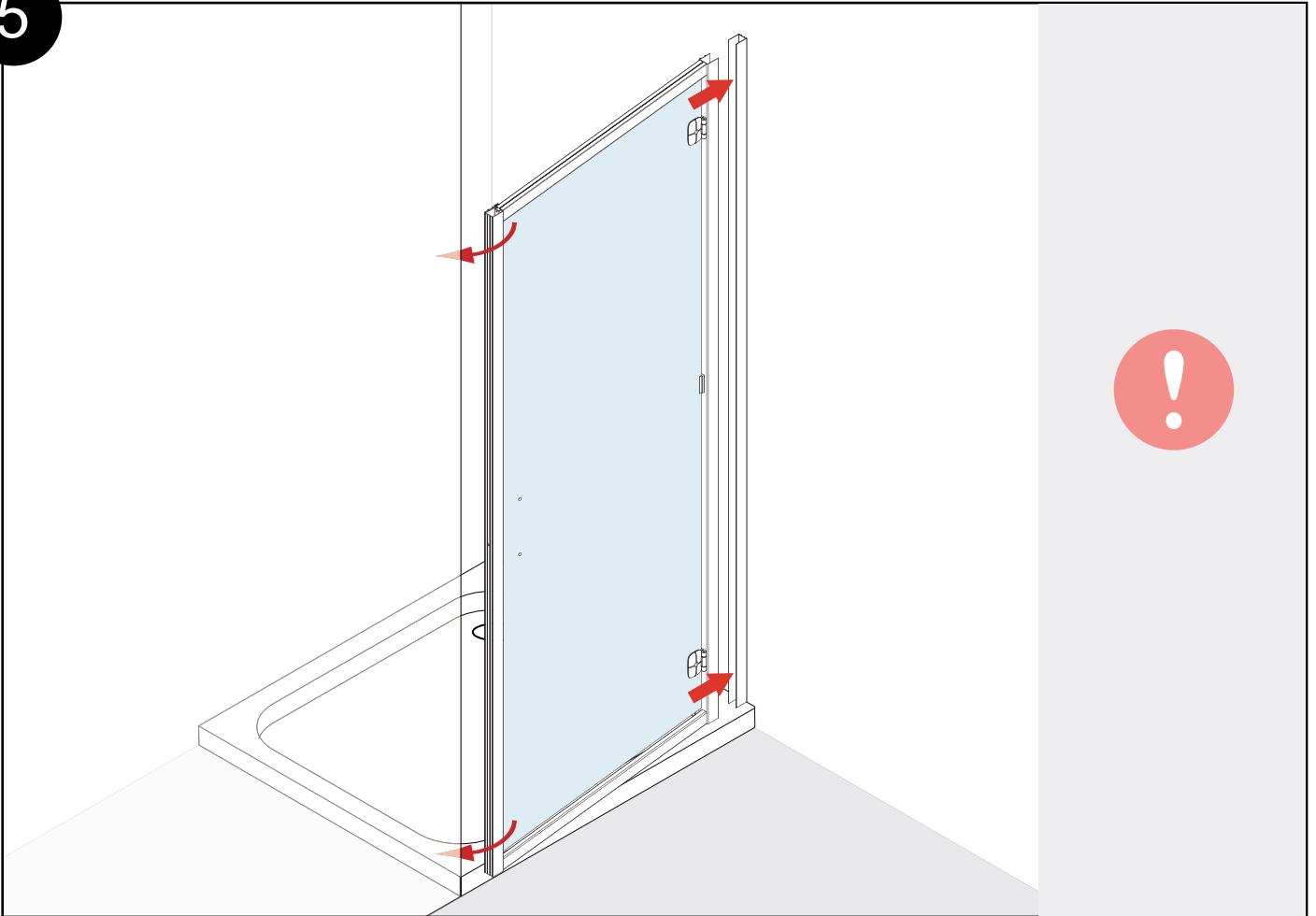

6

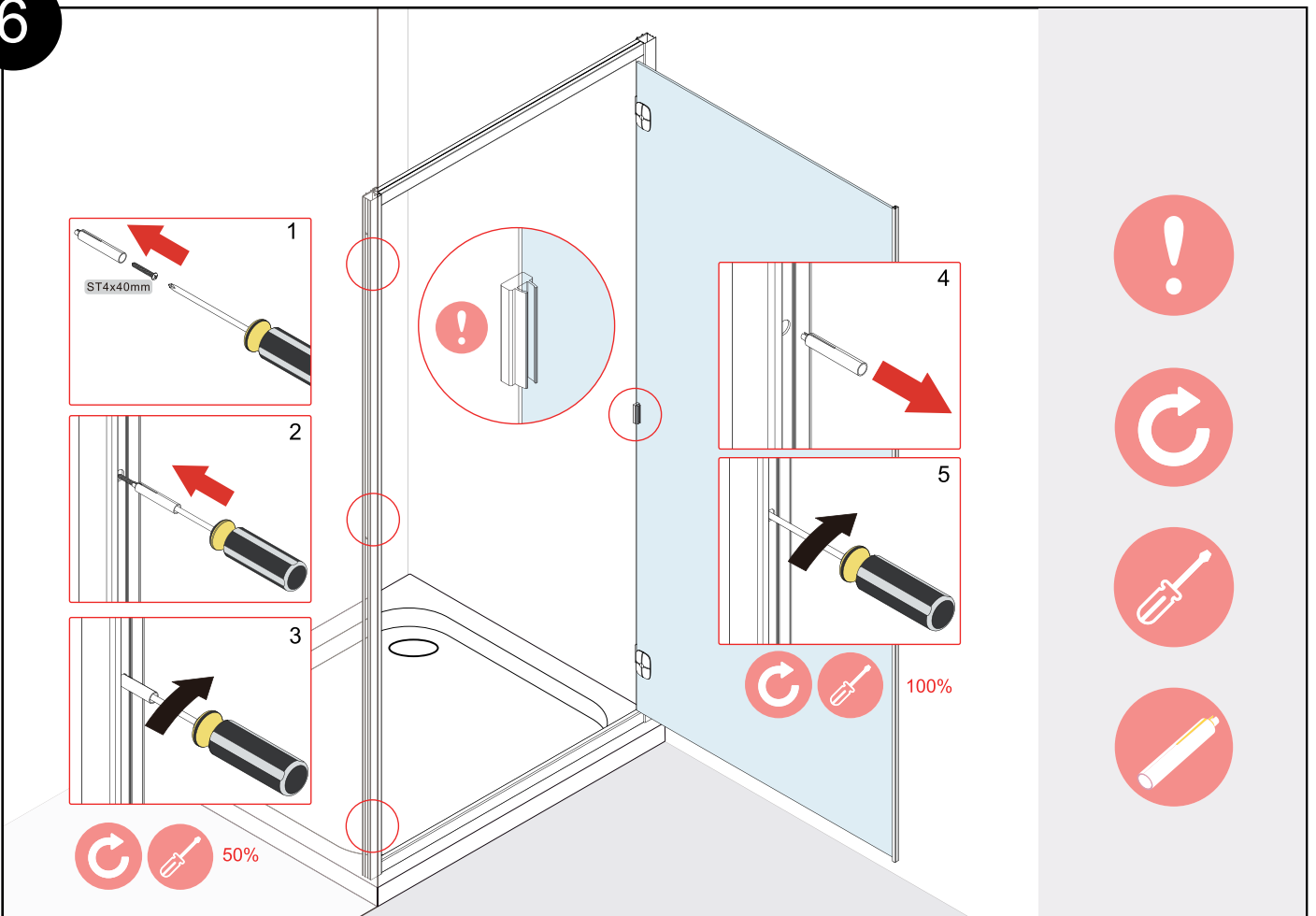

7

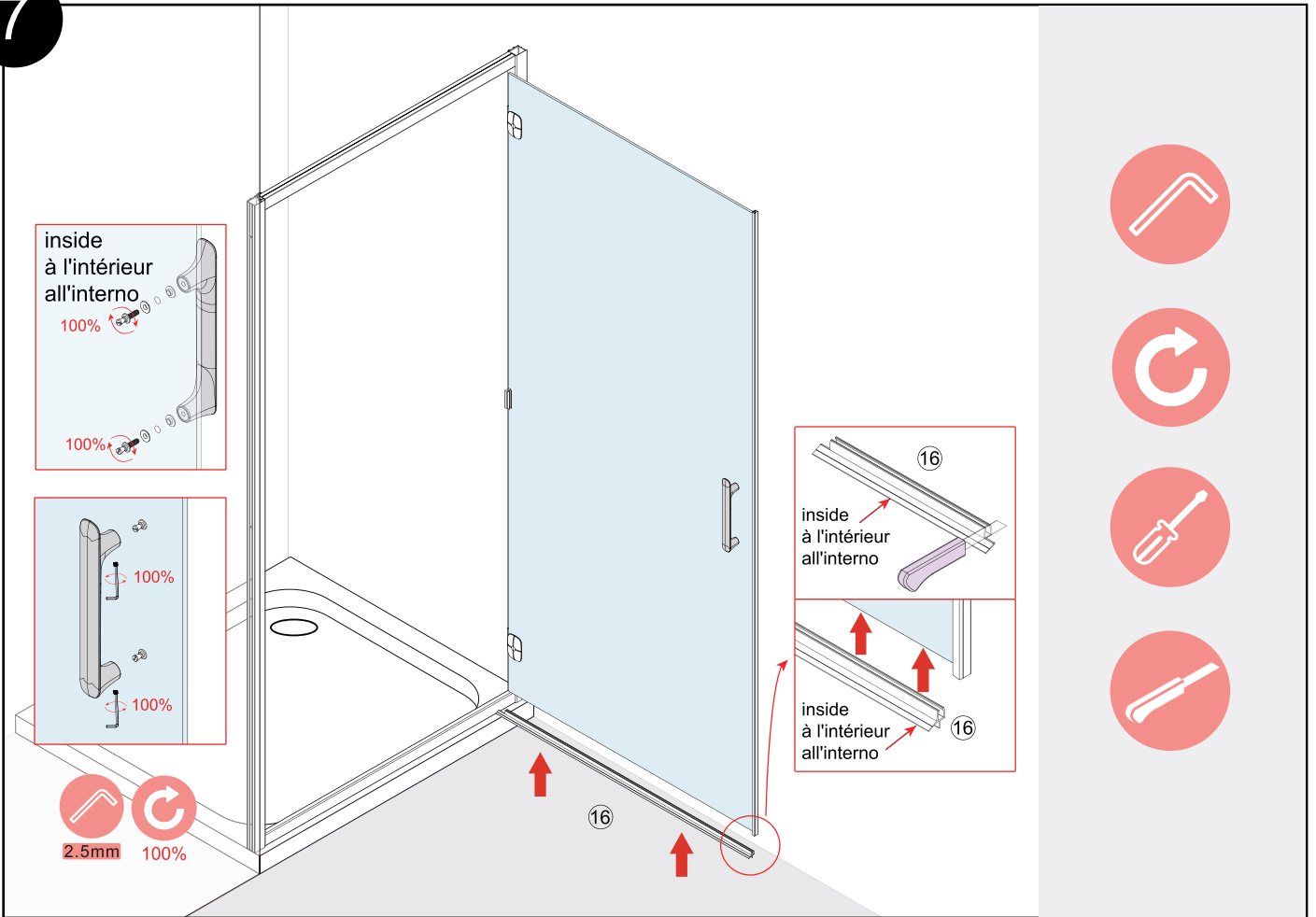

8

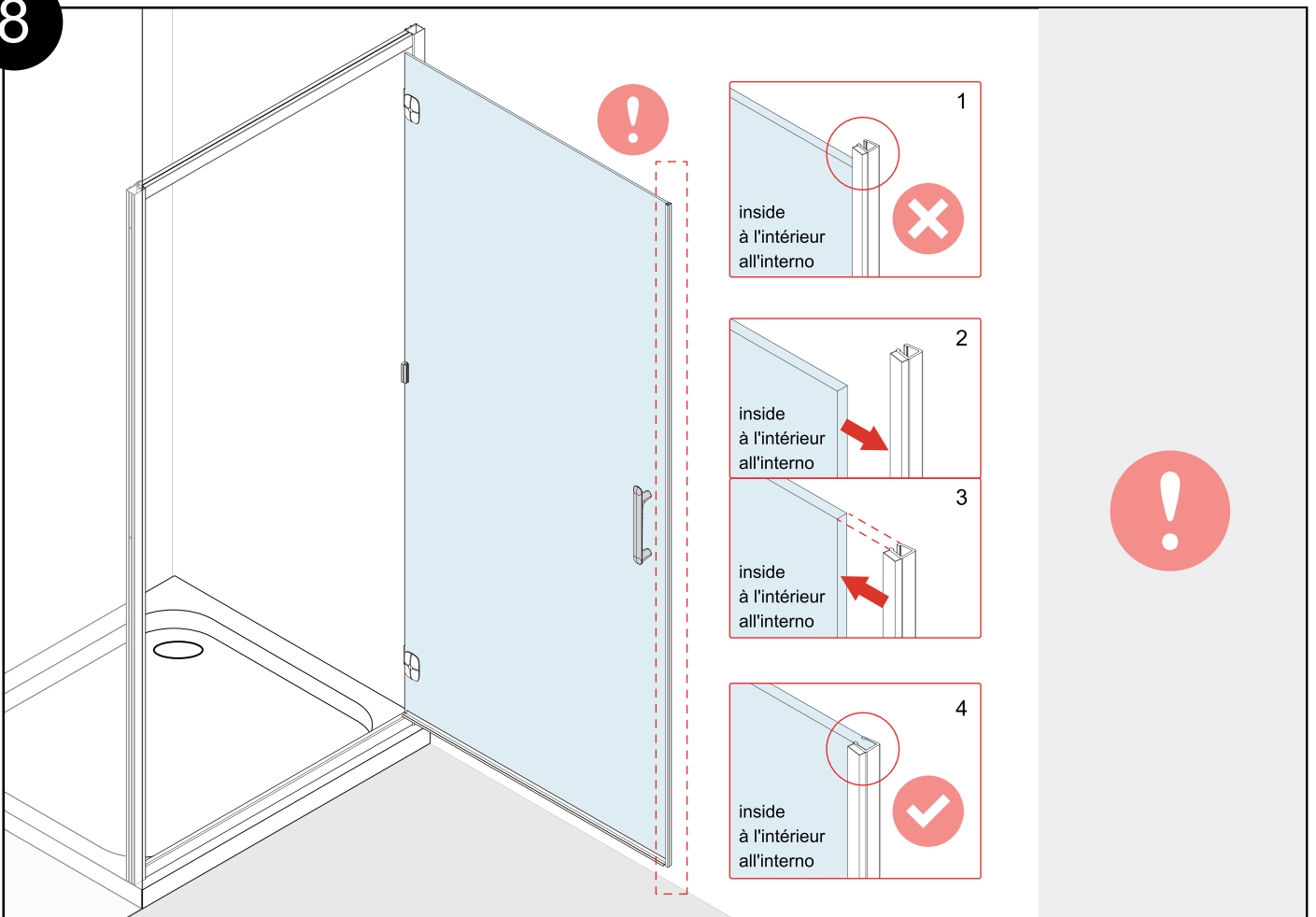

9

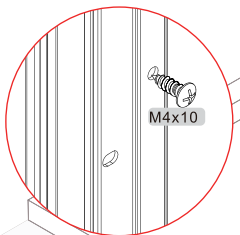
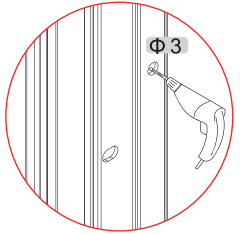
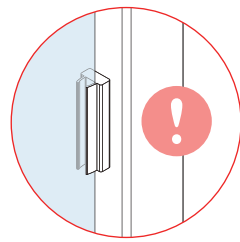

100%

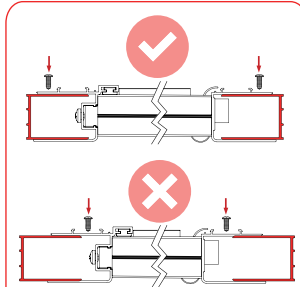
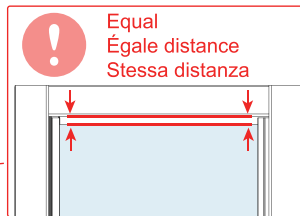
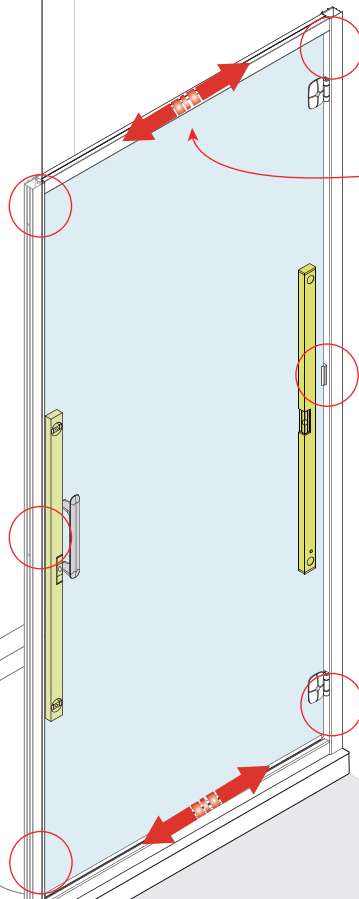

NB: Space profiles in wall jams equal distance from walls on each side.

NB: Placer les profilés de la porte dans les profilés muraux à égale distance des murs de chaque côté.

NB: Usa lo stesso spazio di regolazione nei profili per ciascun muro. (ES. 2 cm a sinistra e 2 cm a destra)



10

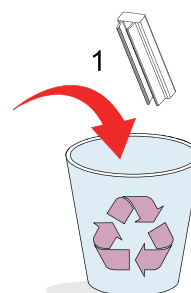
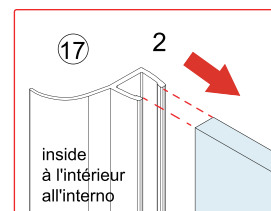
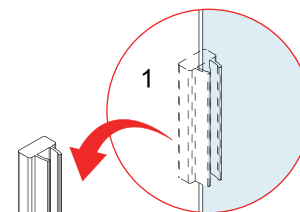
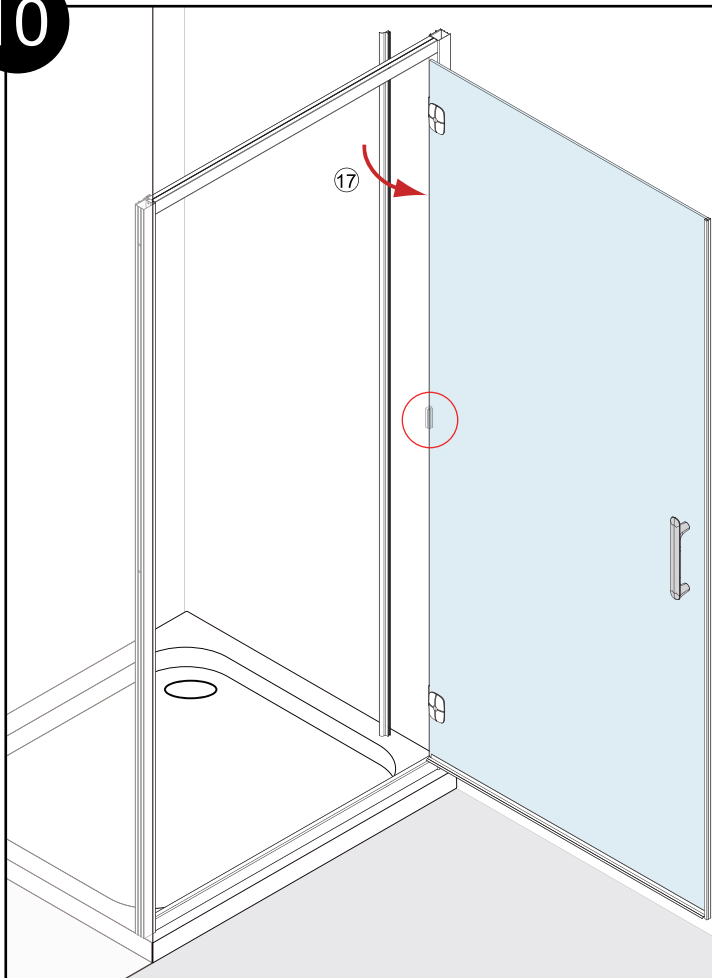

11

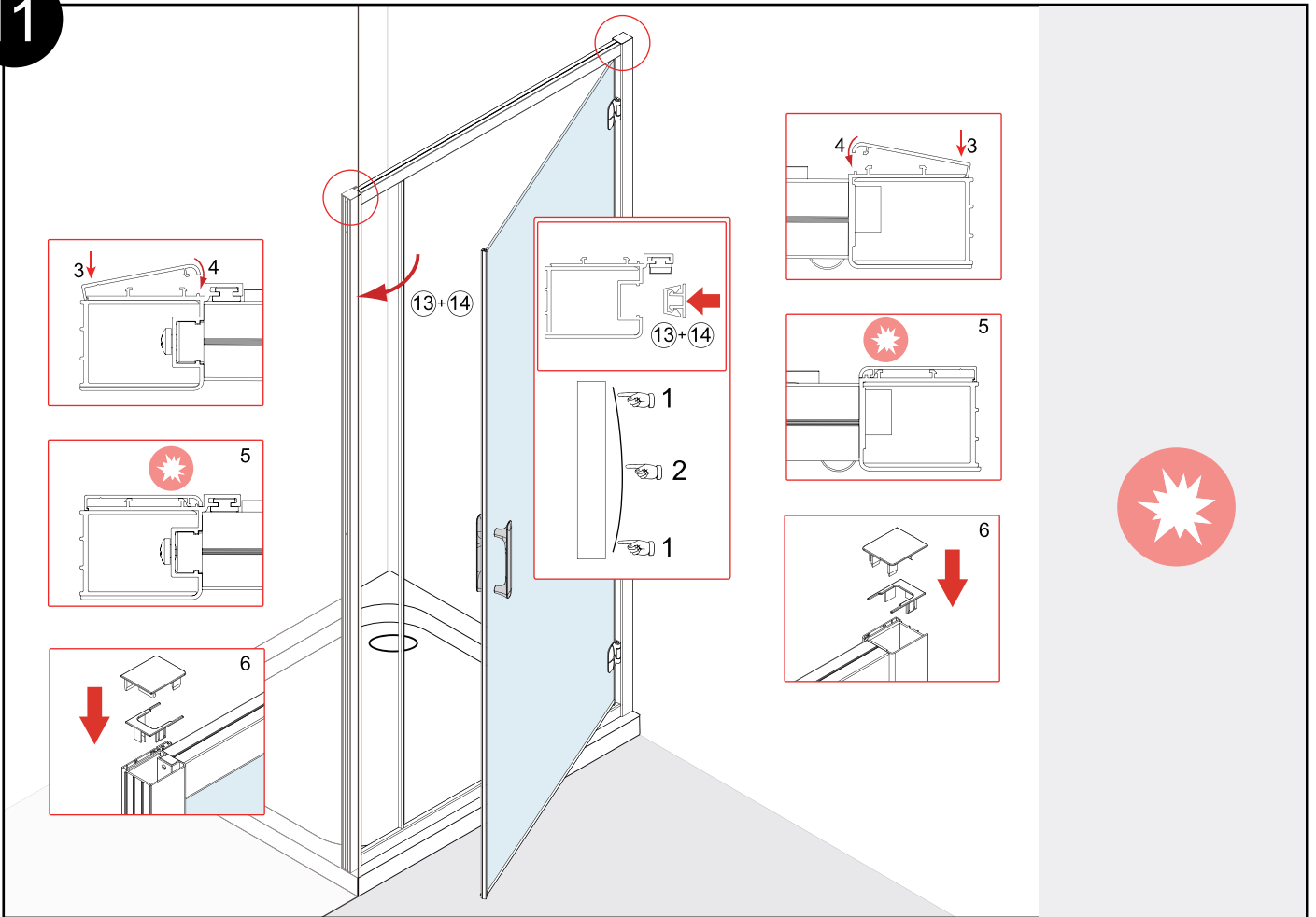

12

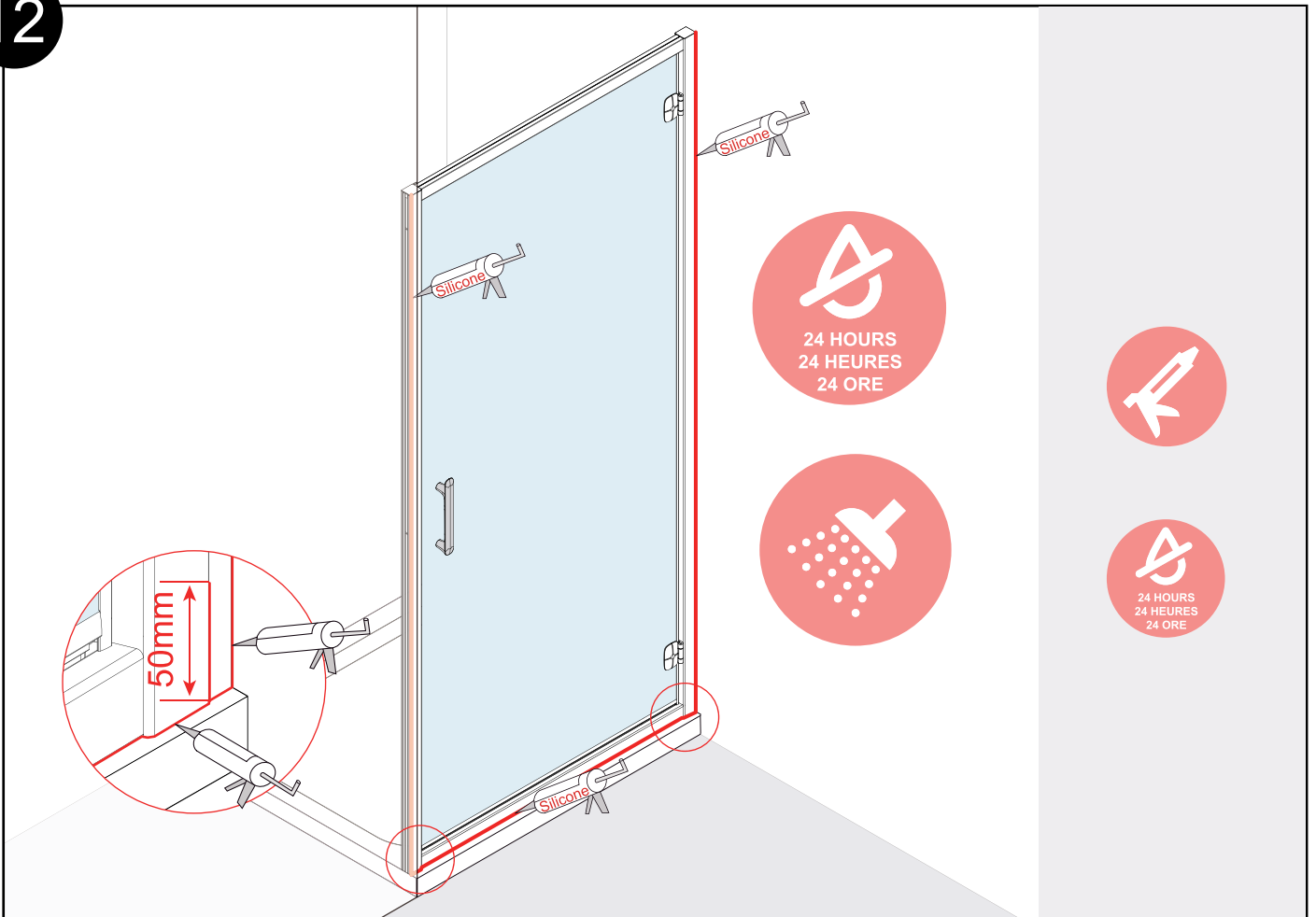

A

Dis-assembly
Démontage
Smontaggio

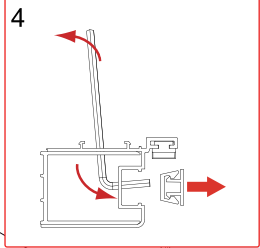
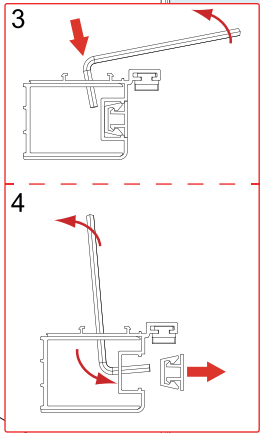
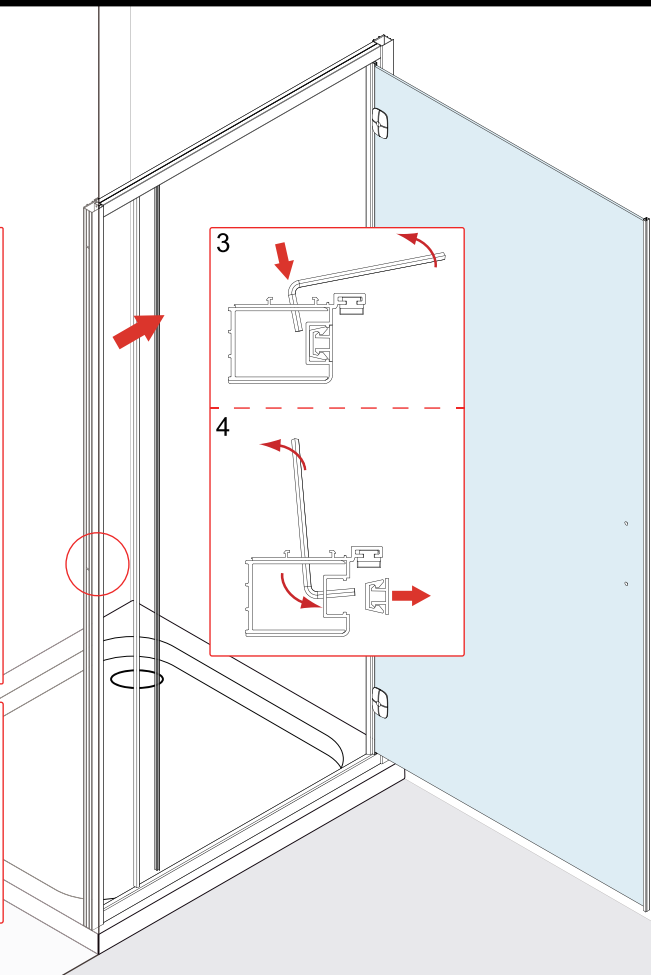
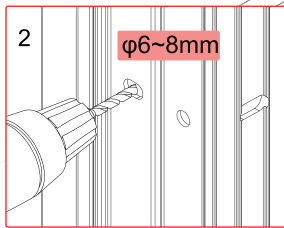
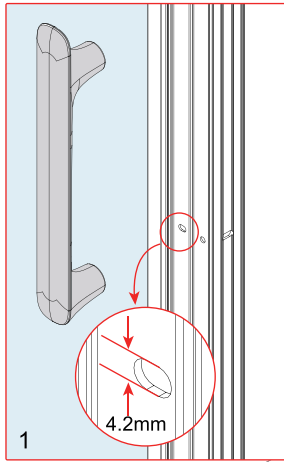

INSTALLATION & MAINTENANCE

INSTALLATION TIPS

It is the responsibility of the installer to ensure that the product is installed correctly and due care is given to the instructions.

Your guarantee is invalid if the instructions have not been followed correctly.

- Please check for all visual defects on the product before installation - such defects will not be accepted after installation of the product
- For shower enclosures a spirit level should be used to ensure your shower tray is level - if the shower tray is not level your shower door will not fit
- Ensure vertical wall profiles are level and are an equal distance in from the tray
- Ensure adjustment at wall profiles are equal at both sides and that all screws are fully tightened
- Ensure hinges are level and securely fitted to the glass
- Ensure magnets are the right orientation and are attracting rather than repelling
- Ensure silicone is used to waterproof your shower enclosure
- Care must be taken during assembly. Flair will not take responsibility where incorrect assembly results in undue stress being put on any of the glass components in this product
- If there are any manufacturing problems please call Flair Service Line on +353 42 966 8000

CLEANING

ClearVue Glass coating is a standard feature on all ILLI shower doors. This easy to clean glass coating is applied to the glass surface and ensures that soap deposits and lime scale are easily cleaned off the glass.

Glass: Use a soft cloth and mild detergent, rinse off thoroughly*

Metallic Surfaces: Use a soft cloth and warm soapy water*

Painted Surfaces: Use a soft cloth & mild detergent, rinse off thoroughly*

*Do not use "Spray & leave" cleaning products on the metal surface as these will cause damage to your shower door. These include acidic based cleaning products, bleaches, solvents or abrasive pads. These will damage the anodising layer on the aluminium profiles.

*In hard water areas, regular cleaning of your Flair door will help to prevent the buildup of limescale. Stubborn deposits of limescale can be removed with the use of a mild limescale remover.

*Only use detergents, cleaners and limescale removers with a pH of 5-8.

*The constant use of detergents will degrade the finish of the product over time if not thoroughly rinsed off.

MAINTENANCE TIPS

- Check your shower door for functionality periodically
- Only use non-abrasive cleaning agents on all Flair products and rinse off thoroughly.
- Do not use excessive force when opening and closing your shower door as this could result in shattering
- Do not hang from your shower door or shower door handle - it is not designed to support excessive weight.

INSTALLATION ET MAINTENANCE

CONSEILS POUR L'INSTALLATION

Il est de la responsabilité de l'installateur d'assurer que le produit soit installé correctement en fonction des instructions de montage.

Avant d'installer le produit, lisez attentivement toutes les instructions.

Si les instructions n'ont pas été correctement suivies votre garantie s'en trouvera annulée.

- Veuillez vérifier que le produit ne comporte pas de défaut visible avant installation. Aucune réclamation ne sera acceptée une fois le produit installé.
- Vérifiez à l'aide d'un niveau que le receveur soit installé parfaitement à plat avant d'installer votre porte. Si le receveur n'est pas à niveau le montage de la porte ne sera pas possible.
- Positionner les profilés verticaux muraux à une distance égale du bord extérieur du receveur.
- Assurez-vous que les profilés muraux verticaux soient à niveau et droits et que toutes les vis soient bien serrées.
- Assurez-vous que les charnières soient à niveau et bien fixées sur le verre
- Assurez-vous que les aimants soient montés correctement et qu'ils s'attirent plutôt qu'ils se repoussent
- Sceller la porte de douche avec du silicone pour assurer l'étanchéité.
- Une attention particulière doit être prêtée lors de l'assemblage. Flair déclinera toute responsabilité si une mauvaise installation aboutit à des dégâts ou des pertes importantes.
- Attention : les panneaux en verre sont fragiles et sont donc à manipuler avec précautions.
- Pour tout défaut de fabrication, contactez nous au : + 353 42 96 94436.

NETTOYAGE

Le traitement "ClearVue Glass" est une caractéristique standard de toutes les portes ILLI. Ce revêtement est appliqué sur la surface du verre et permet d'éliminer facilement les dépôts de savon et de calcaire.

- | | |
|-----------------------|--|
| Verre : | Utilisez un chiffon et un détergent doux, rincer abondamment.* |
| Surfaces métalliques: | Utilisez un chiffon doux et de l'eau chaude savonneuse.* |
| Surfaces peintes : | Utilisez un chiffon et un détergent doux, rincer abondamment.* |

*Ne pas utiliser de produit sans rinçage sur les produits métalliques car cela risque de les endommager. Ces produits contiennent des ingrédients avec des bases acides, des décolorants, des solvants ou des gommages abrasifs qui peuvent endommager la couche d'anodisation sur les profilés en aluminium.

*Dans les zones ayant une eau très calcaire, un nettoyage régulier de la porte de douche aidera à prévenir l'accumulation de dépôt calcaire. On peut enlever ces dépôts avec un détartrant doux.

*Utilisez uniquement des produits de nettoyage avec un pH compris entre 5 et 8.

*L'utilisation constante de détergents dégradera la finition du produit au cours du temps si le rinçage n'est pas effectué soigneusement.

CONSEILS DE MAINTENANCE

- Vérifiez votre porte de douche pour la fonctionnalité périodiquement.
- Utilisez uniquement des produits de nettoyage non abrasifs sur toutes les portes de douche de Flair. Toujours rincer abondamment.
- Ne pas utiliser une force excessive pour ouvrir et fermer la porte, cela pourrait casser le verre.
- Évitez de vous suspendre sur les portes ILLI, elles ne sont pas conçues pour supporter des poids excessifs.

INSTALLAZIONE E MANTENIMENTO

CONSIGLI D'INSTALLAZIONE

È responsabilità dell'installatore assicurare che il prodotto venga montato correttamente nel rispetto delle istruzioni.

La garanzia è invalida se il prodotto è stato installato non rispettando le istruzioni di montaggio.

- Siete pregati di verificare che non ci siano difetti visibili prima di procedere con l'installazione. Ogni reclamo pervenuto ad installazione avvenuta non verrà accettato.
- Verificare che il piatto doccia sia perfettamente in bolla altrimenti la doccia non potrà essere installata.
- Assicurarsi che le pareti siano livellate e ci sia la stessa distanza dal piatto doccia.
- Assicurarsi che la regolazione nei profili sia uguale in entrambe le parti e che tutte le viti siano avvitate completamente.
- Assicurarsi che i cardini siano livellati e montati correttamente sul vetro.
- Verificare che i magneti siano nella direzione corretta, cioè si dovrebbero attrarre non il contrario.
- Usare silicone per assicurare la porta doccia contro le fuoriuscite d'acqua.
- Maneggiare con estrema cura durante l'installazione, Flair non accetta alcuna responsabilità in caso di rottura del vetro a causa di pressioni su di esso in questa fase.
- In caso di difetti di produzione contatti il +39 0287368301 oppure: assistenzaclienti@flairshowers.com

PULIZIA

Tutti i prodotti ILI hanno il trattamento anticalcare. Questo trattamento è applicato sulla superficie del vetro per rendere facile la pulizia di eventuali residui di sapone e del calcare.

Vetro:	utilizzare un panno e detersivi non corrosivi, infine risciacquare abbondantemente.*
Superfici metalliche:	utilizzare un panno e acqua tiepida con poco sapone.*
Superfici verniciate:	utilizzare un panno e detersivi non corrosivi, infine risciacquare abbondantemente.*

*NON utilizzare prodotti che non richiedono il risciacquo sulle parti metalliche, perché si potrebbero danneggiare. Questo include l'uso di prodotti di pulizia aggressivi: candeggina, acidi, solventi o spugne abrasive. Questi danneggiano lo strato protettivo del profilo in alluminio.

*Nelle aree con presenza di acque dure è consigliato pulire ed asciugare regolarmente le pareti doccia, al fine di evitare la deposizione di calcare. I depositi ostinati di calcare possono essere rimossi con l'uso di un anticalcare gentile.

*UTILIZZARE SOLO DETERSIVI PER LA PULIZIA OPPURE ANTI-CALCARE CON PH 5-8.

*L'utilizzo frequente di detersivi comporterà, nel tempo, la perdita della brillantezza dell'alluminio se non viene risciacquato abbondantemente.

CONSIGLI PER IL MANTENIMENTO

- Verificare periodicamente la funzionalità delle porte doccia
- Utilizzare solo detergenti non abrasivi su tutti i prodotti Flair. Sempre risciacquare abbondantemente.
- Non effettuare troppa pressione nell'apertura o nella chiusura della porta in quanto questo potrebbe causare la rottura del vetro.
- Non appoggiarsi alla maniglia della porta doccia, questa non è stata disegnata per sostenere troppo peso.

DESIGNED FOR LIFE

Flair Showers Ltd.
Rocks Road
Kingscourt
Co Cavan
Ireland

T +353 42 966 8000

E sales@flairshowers.com

ventes@flairshowers.com

(France+Benelux)

assistenzaclienti@flairshowers.com

(Italia + España)

Connect with us



FLAIRSHOWERS.COM