

---

CREATING  
PERFECT  
HARMONY

ORO

flair  
—



---

CREATING  
PERFECT  
HARMONY



## PRODUCT DESIGN AWARD WINNER

Flair are proud to have received three design accolades, in recognition of the ORO frameless shower door collection.

The Good Design Award, RedDot Award, and iF Design Award are seals of global design excellence and a testimony to our passion for product quality and innovation.



## THE ORO<sup>®</sup> COLLECTION

At Flair we understand that our customers have an ever demanding daily routine. Be it first thing in the morning or as you finish the day, a shower has the power to lift your spirits, calm the mind and invigorate.

In creating the ORO range, our aim is to enrich lives with beautifully designed products for living and giving, that are a pleasure to use.

With a graceful aesthetic, the award winning ORO collection is a union of design innovation and functional perfection. The hand crafted ORO door handles are one of a kind and distinctly individual. Elegance shines through the curved profile and hinge detailing. Each ORO component is carefully considered to enhance your experience every day.

As you explore the ORO catalogue, we hope you are captivated by every detail.



---

# VISIONARY INNOVATIONS

COUNTERSUNK INTERIOR HINGES  
WITH FLUSH TO GLASS FINISH



CURVED HINGE  
DETAILING



SIGNATURE  
HANDLE  
DESIGN



UNIQUELY CRAFTED  
BI-FOLD HANDLE

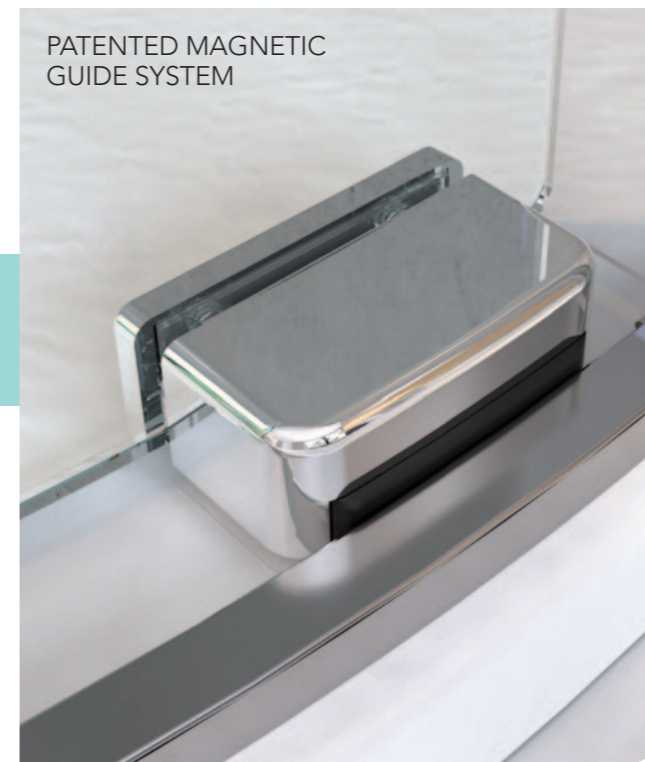

PATENTED MAGNETIC  
GUIDE SYSTEM

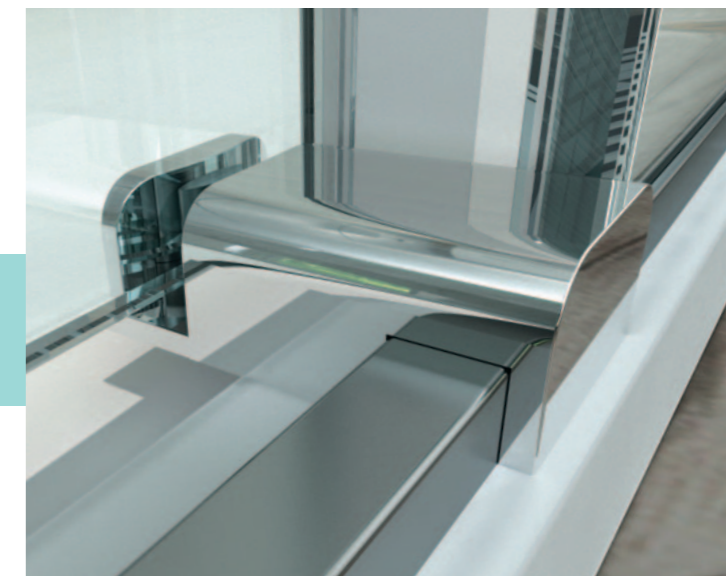

MINIMALIST BOTTOM  
DOOR GUIDE

---

# FUNCTIONAL INNOVATIONS

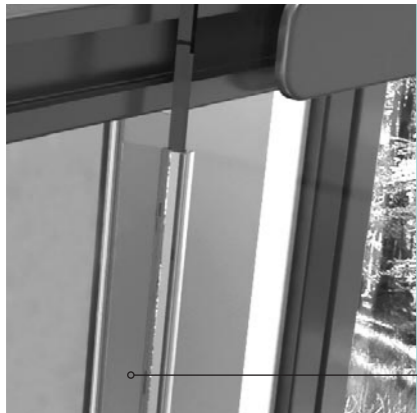

ULTRA  
CLEAR  
DOOR  
SEALS

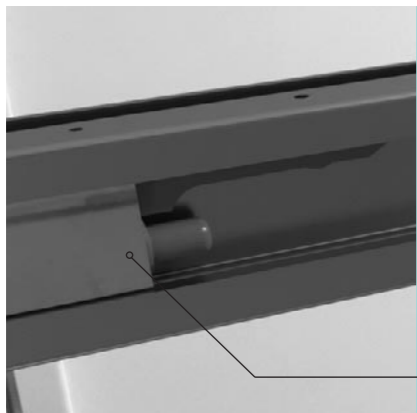

CUSHION  
CLOSE  
DAMPENER  
SYSTEM



CURVED  
RADIUS  
DETAILING  
THROUGHOUT



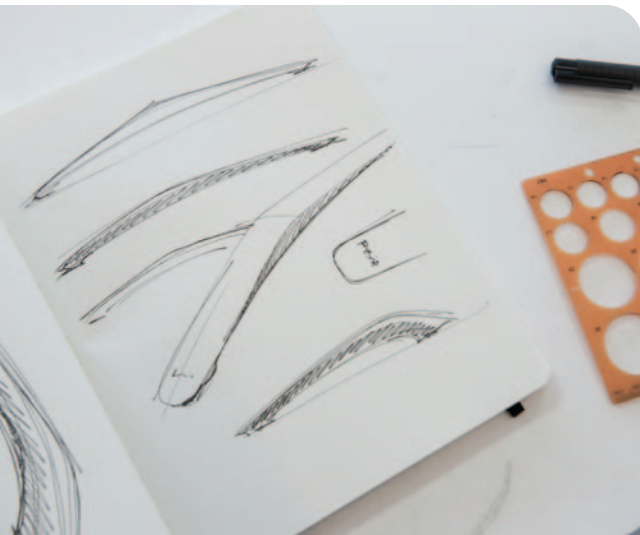

IDEA  
CONCEPT  
PROTOTYPE  
ORO



VISIONARY  
DETAILS

	<p>2 METRES HIGH</p>		<p>CONCEALED INTERIOR FIXATION POINTS</p>
	<p>8mm TOUGHENED SAFETY GLASS TO EN12150</p>		<p>INNOVATIVE ULTRA CLEAR SEALS</p>
	<p>CLEARVUE IS A HYDROPHOBIC GLASS COATING THAT RESISTS THE BUILD UP OF LIMESCALE AND GRIME ON THE GLASS SURFACE</p>		<p>SUITABLE FOR SHOWER TRAY OR WETROOM FLOOR INSTALLATION</p>
	<p>UNIQUELY CRAFTED CHROME PLATED HANDLE</p>		

# THE ORO® ULTRA FRAMELESS COLLECTION

HINGE & INLINE DOOR WITH ULTRA FRAMELESS CORNER SIDE PANEL

12

HINGE DOOR WITH ULTRA FRAMELESS CORNER SIDE PANEL

14

BIFOLD DOOR WITH ULTRA FRAMELESS CORNER SIDE PANEL

16

# THE ORO® COLLECTION

SLIDER DOOR

18

HINGE DOOR

20

HINGE & INLINE DOOR

22

HINGE & INLINE DOOR

28

BIFOLD DOOR

24

HINGED QUADRANT DOOR

26

HINGED OFFSET QUADRANT DOOR

28

SLIDING QUADRANT DOOR

30

SLIDING OFFSET QUADRANT DOOR

32

GEMSTONE SHOWER TRAYS

34

COMMERCIAL PROJECTS

54

QUALITY GUARANTEED

58

# HINGE AND INLINE DOOR WITH ULTRA FRAMELESS CORNER SIDE PANEL

Setting the standard in frameless design, the Hinge and Inline door with ultra frameless corner side panel will make a real style statement in your bathroom.

A generously proportioned shower enclosure, this modular design is ideal for larger showering spaces. With durability in mind, the corner side panel is supported by a minimalist chrome stabilising bar.

## STEP 1 - SELECT ULTRA FRAMELESS CORNER SIDE PANEL

PRODUCT DESCRIPTION	ADJUSTMENT	CODE
Ultra Frameless Corner Side Panel 700mm	660 - 680mm	OROCSP70SC
Ultra Frameless Corner Side Panel 760mm	720 - 740mm	OROCSP76SC
Ultra Frameless Corner Side Panel 800mm	760 - 780mm	OROCSP80SC
Ultra Frameless Corner Side Panel 900mm	860 - 880mm	OROCSP90SC
Ultra Frameless Corner Side Panel 1000mm	960 - 980mm	OROCSP100SC

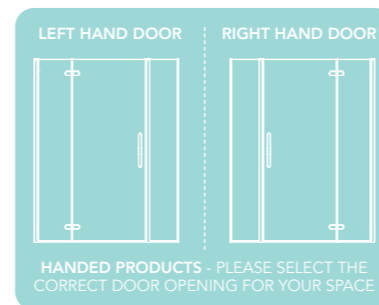

## HINGE AND INLINE DOOR SIZE PLUS CORNER INLINE PANEL SIZE WILL TOTAL TO THE WIDTH OF YOUR SHOWER TRAY.

## STEP 2 - SELECT HINGE AND INLINE DOOR

PRODUCT DESCRIPTION	ADJUSTMENT SIZE MIN	ADJUSTMENT SIZE MAX	ACCESS	CODE
Hinge and Inline Door 1100mm <b>Left Hand</b>	1060mm	1080mm	723mm	OROHD110LSC
Hinge and Inline Door 1100mm <b>Right Hand</b>	1060mm	1080mm	723mm	OROHD110RSC

(Door Width = 754mm / Inline Panel Width = 285mm)\*

PRODUCT DESCRIPTION	ADJUSTMENT SIZE MIN	ADJUSTMENT SIZE MAX	ACCESS	CODE
Hinge and Inline Door 1200mm <b>Left Hand</b>	1160mm	1180mm	723mm	OROHD120LSC
Hinge and Inline Door 1200mm <b>Right Hand</b>	1160mm	1180mm	723mm	OROHD120RSC

(Door Width = 754mm / Inline Panel Width = 385mm)\*

\*Tolerance of 20mm in the inline panel measurement reflecting the 20mm profile adjustment.

## STEP 3 - CHOOSE CORNER INLINE PANEL KIT

PRODUCT DESCRIPTION	CODE
Corner Inline Panel 100mm Kit	OROKIT5
Corner Inline Panel 200mm Kit	OROKIT6
Corner Inline Panel 300mm Kit	OROKIT7
Corner Inline Panel 400mm Kit	OROKIT8

**NOTE - Each corner inline panel kit includes 3 components - inline panel, bottom barrier bar and corner stabilising bar with fixing brackets. Ultra clear seal and 3M tape option are both supplied for corner inline panel fixation.**

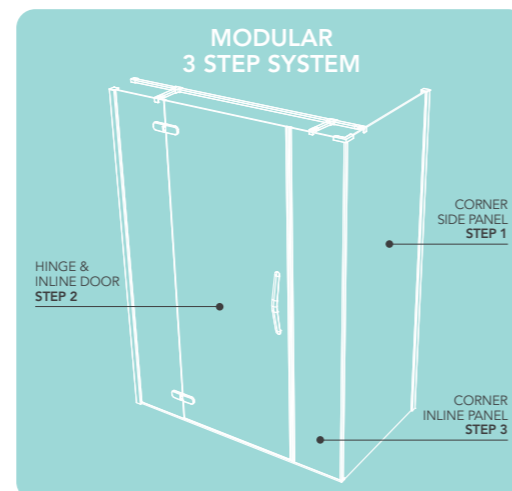

ORO LEFT HAND HINGE AND INLINE DOOR WITH FRAMELESS CORNER SIDE PANEL

<b>8mm</b> TOUGHENED SAFETY GLASS	<b>2000mm</b> HEIGHT	<b>20mm</b> CORNER SIDE PANEL ADJUSTMENT	<b>20mm</b> DOOR ADJUSTMENT	<b>10mm</b> ULTRA LOW BOTTOM RAIL
CRAFTED HANDLE DESIGN	ULTRA CLEAR SEALS	SEAMLESS INTERIOR COVER STRIPS	SUITABLE FOR SHOWER TRAY INSTALLATION ONLY	CLEARVUE GLASS COATING

# HINGE DOOR WITH ULTRA FRAMELESS CORNER SIDE PANEL

The ORO Hinge Door and ultra frameless corner side panel radiates style and contemporary elegance.

This corner side panel system is modular, giving you flexibility with your door and inline panel sizing to suit your shower tray. Minimally designed but with durability in mind, the corner side panel is supported by a sleek chrome stabilising bar.

## STEP 1 - SELECT ULTRA FRAMELESS CORNER SIDE PANEL

PRODUCT DESCRIPTION	ADJUSTMENT	CODE
Ultra Frameless Corner Side Panel 700mm	660 - 680mm	OROCSP70SC
Ultra Frameless Corner Side Panel 760mm	720 - 740mm	OROCSP76SC
Ultra Frameless Corner Side Panel 800mm	760 - 780mm	OROCSP80SC
Ultra Frameless Corner Side Panel 900mm	860 - 880mm	OROCSP90SC
Ultra Frameless Corner Side Panel 1000mm	960 - 880mm	OROCSP100SC

**HINGE DOOR SIZE PLUS CORNER INLINE PANEL SIZE WILL TOTAL TO THE WIDTH OF YOUR SHOWER TRAY.**

## STEP 2 - SELECT HINGE DOOR

PRODUCT DESCRIPTION	ADJUSTMENT SIZE		ACCESS	CODE
	MIN	MAX		
Hinge Door 800mm	760mm	780mm	637mm	OROHD80SC
Hinge Door 900mm	860mm	880mm	737mm	OROHD90SC
Hinge Door 1000mm	960mm	980mm	837mm	OROHD100SC

## STEP 3 - CHOOSE CORNER INLINE PANEL KIT

PRODUCT DESCRIPTION	CODE
Corner Inline Panel 100mm Kit	OROKIT1
Corner Inline Panel 200mm Kit	OROKIT2
Corner Inline Panel 300mm Kit	OROKIT3
Corner Inline Panel 400mm Kit	OROKIT4

**NOTE - Each corner inline panel kit includes 3 components - inline panel, bottom barrier bar and corner stabilising bar with fixing brackets. Ultra clear seal and 3M tape option are both supplied for corner inline panel fixation.**

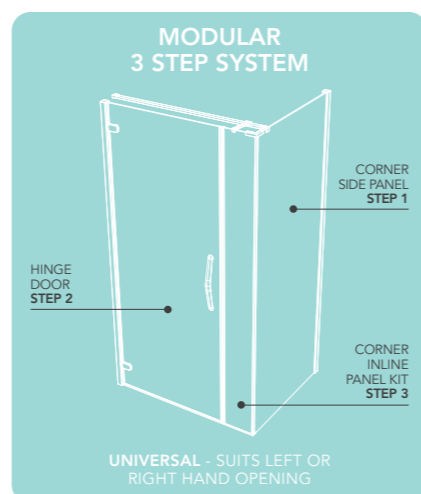

<b>8mm</b> TOUGHENED SAFETY GLASS	<b>2000mm</b> HEIGHT	<b>20mm</b> CORNER SIDE PANEL ADJUSTMENT	<b>20mm</b> DOOR ADJUSTMENT	<b>10mm</b> ULTRA LOW BOTTOM RAIL	SUITABLE FOR SHOWER TRAY INSTALLATION ONLY
CRAFTED HANDLE DESIGN	ULTRA CLEAR SEALS	SEAMLESS INTERIOR COVER STRIPS	UNIVERSAL LEFT OR RIGHT HAND OPENING	CLEARVUE GLASS COATING	



ORO HINGE DOOR AND FRAMELESS CORNER SIDE PANEL (LEFT HAND INSTALLATION)



# BIFOLD DOOR WITH ULTRA FRAMELESS CORNER SIDE PANEL

The ORO Bifold and ultra frameless corner side panel is a truly versatile shower door choice. Designed to open both inwards and outwards, the self stop hinge mechanism prevents the bifold door from folding into contact with the glass panels. The **raised stabilising bar** is engineered to accompany the **frameless corner side panel** and with its extra height, allows the door to fold inwards without restriction.

## STEP 1 - SELECT ULTRA FRAMELESS CORNER SIDE PANEL

PRODUCT DESCRIPTION	ADJUSTMENT	CODE
Ultra Frameless Corner Side Panel 700mm	660 - 680mm	OROCSP70SC
Ultra Frameless Corner Side Panel 760mm	720 - 740mm	OROCSP76SC
Ultra Frameless Corner Side Panel 800mm	760 - 780mm	OROCSP80SC
Ultra Frameless Corner Side Panel 900mm	860 - 880mm	OROCSP90SC
Ultra Frameless Corner Side Panel 1000mm	960 - 980mm	OROCSP100SC

**BIFOLD DOOR SIZE PLUS CORNER INLINE PANEL SIZE WILL TOTAL TO THE WIDTH OF YOUR SHOWER TRAY.**

## STEP 2 - SELECT BI-FOLD DOOR

PRODUCT DESCRIPTION	ADJUSTMENT SIZE		ACCESS	CODE
	MIN	MAX		
Bifold Door 700mm	660mm	680mm	488mm	OROBF70SC
Bifold Door 760mm	720mm	740mm	454mm	OROBF76SC
Bifold Door 800mm	760mm	780mm	563mm	OROBF80SC
Bifold Door 900mm	860mm	880mm	663mm	OROBF90SC
Bifold Door 1000mm	960mm	980mm	763mm	OROBF100SC

## STEP 3 - CHOOSE CORNER INLINE PANEL KIT

PRODUCT DESCRIPTION	CODE
Corner Inline Panel 100mm Kit	OROKIT1
Corner Inline Panel 200mm Kit	OROKIT2
Corner Inline Panel 300mm Kit	OROKIT3
Corner Inline Panel 400mm Kit	OROKIT4

**NOTE - Each corner inline panel kit includes 3 components - inline panel, bottom barrier bar and corner stabilising bar with fixing brackets. Ultra clear seal and 3M tape option are both supplied for corner inline panel fixation.**

**8mm**  
TOUGHENED SAFETY GLASS

**2000mm**  
HEIGHT

**20mm**  
CORNER SIDE PANEL ADJUSTMENT

**20mm**  
DOOR ADJUSTMENT

**10mm**  
ULTRA LOW BOTTOM RAIL

**CRAFTED HANDLE DESIGN**

**ULTRA CLEAR SEALS**

**SEAMLESS INTERIOR COVER STRIPS**

**UNIVERSAL LEFT OR RIGHT HAND OPENING**

**CLEARVUE GLASS COATING**

**SUITABLE FOR SHOWER TRAY INSTALLATION ONLY**

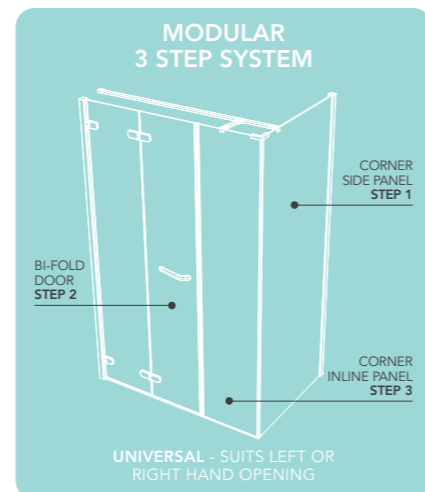



ORO LEFT HAND SLIDER DOOR  
INSTALLED WITH FRAMELESS SIDE PANEL

# SLIDER DOOR

A delightful choice, the ORO Slider Door glides along with smooth perfection. The patented magnetic guide on the bottom of the door is the first of its kind on the market. 8mm toughened safety glass offers a tactile feeling of strength and quality.

The floating top rail design is a signature characteristic of the ORO range. With a seamless interior cover cap, the top rail also cleverly conceals the roller system. The finishing touch is the unique handle design – beautifully formed and a pleasure to use.

## DOOR SIZE OPTIONS

PRODUCT DESCRIPTION	ADJUSTMENT SIZE		ACCESS	CODE
	MIN	MAX		
Sliding Door 1100mm <b>Left Hand</b>	1060mm	1100mm	430mm	OROSA110LSC
Sliding Door 1100mm <b>Right Hand</b>	1060mm	1100mm	430mm	OROSA110RSC
Sliding Door 1200mm <b>Left Hand</b>	1160mm	1200mm	465mm	OROSA120LSC
Sliding Door 1200mm <b>Right Hand</b>	1160mm	1200mm	465mm	OROSA120RSC
Sliding Door 1400mm <b>Left Hand</b>	1360mm	1400mm	565mm	OROSA140LSC
Sliding Door 1400mm <b>Right Hand</b>	1360mm	1400mm	565mm	OROSA140RSC
Sliding Door 1500mm <b>Left Hand</b>	1460mm	1500mm	615mm	OROSA150LSC
Sliding Door 1500mm <b>Right Hand</b>	1460mm	1500mm	615mm	OROSA150RSC
Sliding Door 1600mm <b>Left Hand</b>	1560mm	1600mm	665mm	OROSA160LSC
Sliding Door 1600mm <b>Right Hand</b>	1560mm	1600mm	665mm	OROSA160RSC

## SIDE PANEL OPTIONS

PRODUCT DESCRIPTION	ADJUSTMENT SIZE		CODE
	MIN	MAX	
Side Panel 700mm	670mm	690mm	OROSP70SC
Side Panel 760mm	730mm	750mm	OROSP76SC
Side Panel 800mm	770mm	790mm	OROSP80SC
Side Panel 900mm	870mm	890mm	OROSP90SC
Side Panel 1000mm	970mm	990mm	OROSPI00SC
Side Panel 1200mm	1170mm	1190mm	OROSPI20SC

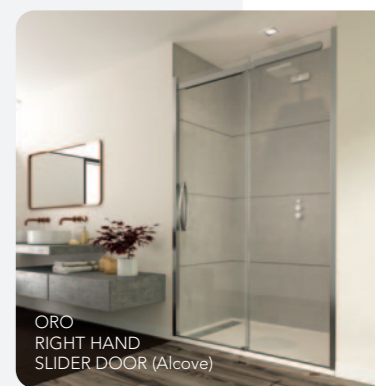

ORO RIGHT HAND SLIDER DOOR (Alcove)

- 8mm TOUGHENED SAFETY GLASS
- 2000mm PROFILE HEIGHT
- 40mm PROFILE ADJUSTMENT
- 10mm ULTRA LOW BOTTOM RAIL
- SEAMLESS INTERIOR COVER STRIPS
- ULTRA CLEAR SEALS
- CUSHION CLOSE DAMPENER MECHANISM
- PATENTED MAGNETIC GUIDE SYSTEM
- CLEARVUE GLASS COATING

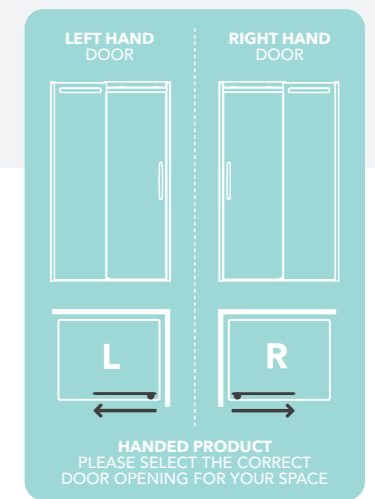

# HINGE DOOR

Experience perfection with the 8mm ORO hinge door. Ideal for smaller spaces, this frameless door features curved radius detailing throughout. Interior fixation points are discreetly concealed by an innovative cover cap design. The countersunk interior hinges allow you to wipe the shower glass clean with ease.

Ultra clear magnetic seals give the hinge door a reassuring close action. The finishing touch is the crafted chrome handles – shaped to give a tactile feeling of smooth perfection.

## DOOR SIZE OPTIONS

PRODUCT DESCRIPTION	ADJUSTMENT SIZE		ACCESS	CODE
	MIN	MAX		
Hinge Door 800mm	760mm	800mm	637mm	OROHD80SC
Hinge Door 900mm	860mm	900mm	737mm	OROHD90SC
Hinge Door 1000mm	960mm	1000mm	837mm	OROHD100SC

## HINGE DOOR OPEN POSITION MEASUREMENTS

DOOR SIZE	DOOR OPEN EXTERNAL PROTRUSION*
800mm	683mm
900mm	783mm
1000mm	883mm

\*Door opens to 90° angle.

## FRAMELESS SIDE PANEL OPTIONS

PRODUCT DESCRIPTION	ADJUSTMENT SIZE		CODE
	MIN	MAX	
Side Panel 700mm	670mm	690mm	OROSP70SC
Side Panel 760mm	730mm	750mm	OROSP76SC
Side Panel 800mm	770mm	790mm	OROSP80SC
Side Panel 900mm	870mm	890mm	OROSP90SC
Side Panel 1000mm	970mm	990mm	OROSP100SC
Side Panel 1200mm	1170mm	1190mm	OROSP120SC

## STABILISING BAR

PRODUCT DESCRIPTION	CODE
Straight Stabilising Bar 1050mm	S-ORO105SSB

Note - Stabilising Bar must be purchased with the Hinge Door & Frameless Side Panel.

## UNIVERSAL - SUITS LEFT OR RIGHT HAND OPENING

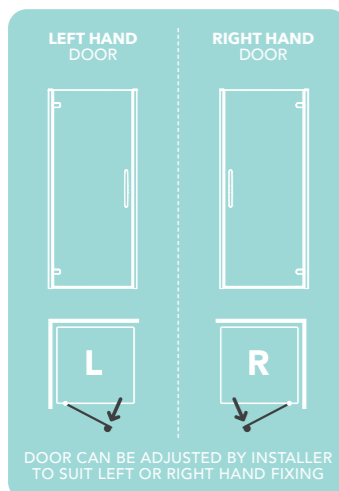

STAINLESS STEEL STRAIGHT STABILISING BAR

- 8mm TOUGHENED SAFETY GLASS
- 2000mm HEIGHT
- 40mm PROFILE ADJUSTMENT
- 10mm ULTRA LOW BOTTOM RAIL
- CRAFTED HANDLE DESIGN
- ULTRA CLEAR SEALS
- SEAMLESS INTERIOR COVER STRIPS
- UNIVERSAL LEFT OR RIGHT HAND OPENING
- CLEARVUE GLASS COATING



ORO HINGE DOOR & SIDE PANEL - LEFT HAND INSTALLATION



ORO HINGE & INLINE DOOR WITH SIDE PANEL - RIGHT HAND INSTALLATION



ORO LEFT HAND HINGE AND INLINE DOOR (alcove)

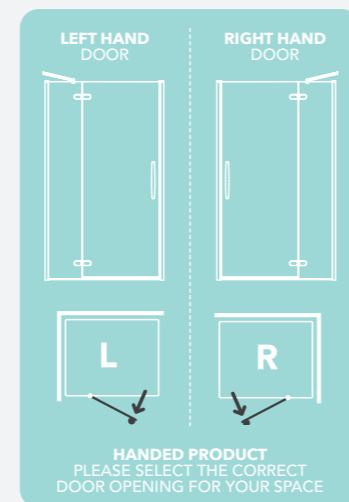

# HINGE & INLINE DOOR

Striking in its appearance, the ORO Hinge and Inline door is a statement piece for your bathroom.

The **gently curved hinges** have a countersunk interior design and can be wiped clean with ease. The **T-bar stabiliser** has concealed fixings and its sleek construction blends subtly into the products profile. Ultra clear magnetic seals giving a superior close action. The finishing touch is the **crafted chrome handles**, their perfect symmetry complementing the overall elegance of the door.

## DOOR SIZE OPTIONS

PRODUCT DESCRIPTION	ADJUSTMENT SIZE		ACCESS	CODE
	MIN	MAX		
Hinge and Inline Door 1100mm <b>Left Hand</b>	1060mm	1100mm	723mm	OROHD110LSC
Hinge and Inline Door 1100mm <b>Right Hand</b>	1060mm	1100mm	723mm	OROHD110RSC
Hinge and Inline Door 1200mm <b>Left Hand</b>	1160mm	1200mm	723mm	OROHD120LSC
Hinge and Inline Door 1200mm <b>Right Hand</b>	1160mm	1200mm	723mm	OROHD120RSC
Hinge and Inline Door 1400mm <b>Left Hand</b>	1360mm	1400mm	723mm	OROHD140LSC
Hinge and Inline Door 1400mm <b>Right Hand</b>	1360mm	1400mm	723mm	OROHD140RSC
Hinge and Inline Door 1600mm <b>Left Hand</b>	1560mm	1600mm	723mm	OROHD160LSC
Hinge and Inline Door 1600mm <b>Right Hand</b>	1560mm	1600mm	723mm	OROHD160RSC

Angled stabilising bar included with each door.

## HINGE & INLINE OPEN POSITION MEASUREMENTS

DOOR SIZE	FIXED INLINE PANEL SIZE	DOOR OPEN EXTERNAL PROTRUSION*
1100mm	350mm	770mm
1200mm	400mm	770mm
1400mm	600mm	770mm
1600mm	750mm	770mm

\*Door opens to 90° angle.

## SIDE PANEL OPTIONS

PRODUCT DESCRIPTION	ADJUSTMENT SIZE		CODE
	MIN	MAX	
Side Panel 700mm	670mm	690mm	OROSP70SC
Side Panel 760mm	730mm	750mm	OROSP76SC
Side Panel 800mm	770mm	790mm	OROSP80SC
Side Panel 900mm	870mm	890mm	OROSP90SC
Side Panel 1000mm	970mm	990mm	OROSP100SC
Side Panel 1200mm	1170mm	1190mm	OROSP120SC

## STABILISING BAR & T PIECE

PRODUCT DESCRIPTION	CODE
Straight Stabilising Bar 1600mm with T Piece	S-ORO160SSB+TB

Note - Stabilising Bar must be purchased with the Hinge & Inline Door & Frameless Side Panel.



T-BAR STABILISER

- 8mm**  
TOUGHENED SAFETY GLASS
- 2000mm**  
HEIGHT
- 40mm**  
PROFILE ADJUSTMENT
- 10mm**  
ULTRA LOW BOTTOM RAIL
- CRAFTED HANDLE DESIGN**
- ULTRA CLEAR SEALS**
- SEAMLESS INTERIOR COVER STRIPS**
- CLEARVUE GLASS COATING**

# BIFOLD DOOR

The ingenious design of the ORO Bifold Door makes it a firm favourite amongst this 8mm shower door range.

The innovative 360 degree hinge mechanism enables the door to open inwards and outwards, offering you total flexibility. A self stop hinge action prevents the door glass extending into contact with the shower wall or door hinges. The bifold hinge is meticulously engineered giving this frameless door exceptional stability. The signature ORO handle design adds the finishing touch to this bijoux beauty.

## DOOR SIZE OPTIONS

PRODUCT DESCRIPTION	ADJUSTMENT SIZE		ACCESS	CODE
	MIN	MAX		
Bifold Door 700mm	660mm	700mm	488mm	OROBF70SC
Bifold Door 760mm	720mm	760mm	454mm	OROBF76SC
Bifold Door 800mm	760mm	800mm	563mm	OROBF80SC
Bifold Door 900mm	860mm	900mm	663mm	OROBF90SC
Bifold Door 1000mm	960mm	1000mm	763mm	OROBF100SC

## SIDE PANEL OPTIONS

PRODUCT DESCRIPTION	ADJUSTMENT SIZE		CODE
	MIN	MAX	
Side Panel 700mm	670mm	690mm	OROSP70SC
Side Panel 760mm	730mm	750mm	OROSP76SC
Side Panel 800mm	770mm	790mm	OROSP80SC
Side Panel 900mm	870mm	890mm	OROSP90SC
Side Panel 1000mm	970mm	990mm	OROSP100SC
Side Panel 1200mm	1170mm	1190mm	OROSP120SC

## STABILISING BAR

PRODUCT DESCRIPTION	CODE
Raised Stabilising Bar 1050mm	S-ORO105HSSB

Note - Stabilising Bar must be purchased with the Bi-Fold door & Frameless Side Panel.

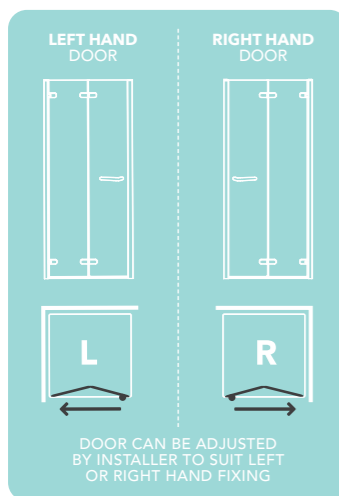

UNIVERSAL - SUITS LEFT OR RIGHT HAND OPENING

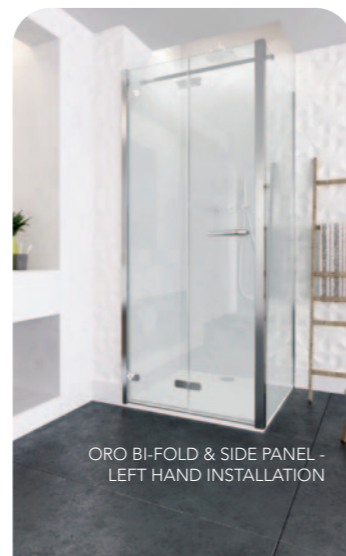

# HINGED QUADRANT DOOR

A hallmark of elegance, the ORO Hinged Quadrant will add a touch of class to your bathroom.

The frameless curved glass is supported by 2 stainless steel stabilising bars that blend seamlessly into the door silhouette. Flush to glass interior **counter sunk hinges** allows you to easily wipe the shower glass clean. Precise in its action, the curved hinge door is secured by **ultra clear magnetic seals** that give the perfect close on this enclosure.

## HINGED QUADRANT OPEN POSITION MEASUREMENTS

DOOR SIZE	STABILISER MEASUREMENT	DOOR OPEN EXTERNAL PROTRUSION*
900mm	350mm	529mm
1000mm	450mm	529mm

\*Door opens to 90° angle.

## DOOR SIZE OPTIONS

PRODUCT DESCRIPTION	ADJUSTMENT SIZE		ACCESS	CODE
	MIN	MAX		
ORO Hinged Quadrant 900mm <b>Left Hand</b>	870mm	890mm	570mm	OROHQ90LSC
ORO Hinged Quadrant 900mm <b>Right Hand</b>	870mm	890mm	570mm	OROHQ90RSC
ORO Hinged Quadrant 1000mm <b>Left Hand</b>	970mm	990mm	570mm	OROHQ100LSC
ORO Hinged Quadrant 1000mm <b>Right Hand</b>	970mm	990mm	570mm	OROHQ100RSC

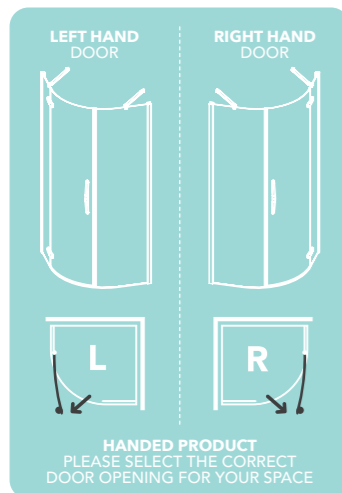

- 8mm TOUGHENED SAFETY GLASS
- 2000mm PROFILE HEIGHT
- 20mm PROFILE ADJUSTMENT
- COUNTERSUNK INTERIOR HINGES
- 10mm ULTRA LOW BOTTOM RAIL
- CRAFTED HANDLE DESIGN
- ULTRA CLEAR SEALS
- SEAMLESS INTERIOR COVER STRIPS
- STAINLESS STEEL ANGLED STABILISING BARS
- CLEARVUE GLASS COATING



ORO RIGHT HAND HINGED QUADRANT



ORO RIGHT HAND OFFSET HINGED QUADRANT  
(to suit right hand offset quadrant shower tray)

# HINGED OFFSET QUADRANT DOOR

Setting the standard in frameless design, the ORO Offset Hinged Quadrant is a shower door of sheer beauty and elegance for your bathroom. The curved frameless glass is supported by 2 minimalist stainless steel stabilising bars. Flush to glass interior counter sunk hinges allow you to easily wipe the shower glass clean.

Precise in its action, the curved hinge door is secured by **ultra clear magnetic seals** that give the perfect close on the shower enclosure.

OFFSET HINGED QUADRANT OPEN POSITION MEASUREMENTS		
DOOR SIZE	STABILISER MEASUREMENT	DOOR OPEN EXTERNAL PROTRUSION*
1000 x 800mm	450mm	529mm
1000 x 900mm	450mm	529mm
1200 x 800mm	650mm	529mm
1200 x 900mm	650mm	529mm

\*Door opens to 90° angle.

## DOOR SIZE OPTIONS

PRODUCT DESCRIPTION	ADJUSTMENT SIZE		ACCESS	CODE
	MIN	MAX		
Offset Hinged Quadrant 1000 x 800mm <b>Left Hand</b>	770-970mm	790-990mm	570mm	OROHQ80X100LSC
Offset Hinged Quadrant 1000 x 800mm <b>Right Hand</b>	770-970mm	790-990mm	570mm	OROHQ80X100RSC
Offset Hinged Quadrant 1000 x 900mm <b>Left Hand</b>	870-970mm	890-990mm	570mm	OROHQ90X100LSC
Offset Hinged Quadrant 1000 x 900mm <b>Right Hand</b>	870-970mm	890-990mm	570mm	OROHQ90X100RSC
Offset Hinged Quadrant 1200 x 800mm <b>Left Hand</b>	770-1170mm	790-1190mm	570mm	OROHQ80X120LSC
Offset Hinged Quadrant 1200 x 800mm <b>Right Hand</b>	770-1170mm	790-1190mm	570mm	OROHQ80X120RSC
Offset Hinged Quadrant 1200 x 900mm <b>Left Hand</b>	870-1170mm	890-1190mm	570mm	OROHQ90X120LSC
Offset Hinged Quadrant 1200 x 900mm <b>Right Hand</b>	870-1170mm	890-1190mm	570mm	OROHQ90X120RSC

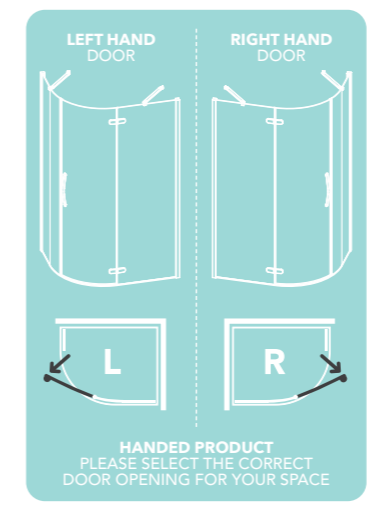

- 8mm** TOUGHENED SAFETY GLASS
- 2000mm** HEIGHT
- 20mm** PROFILE ADJUSTMENT
- COUNTERSUNK INTERIOR HINGES
- 10mm** ULTRA LOW BOTTOM RAIL
- CRAFTED HANDLE DESIGN
- ULTRA CLEAR SEALS
- SEAMLESS INTERIOR COVER STRIPS
- STAINLESS STEEL ANGLED STABILISING BARS
- CLEARVUE GLASS COATING

# SLIDING QUADRANT DOOR

Creative engineering has shaped the unique ORO Sliding Quadrant. The top floating rail design ingeniously encloses the roller system to give the door a sleek polished look. Practically speaking, the concealed rollers ensure reduced cleaning time.

Functional distinction continues with the **patented magnetic guide system** – this design innovation guarantees the smoothest motion as the door glides around the bottom rail. The final detail is the **crafted handle design**, befitting for the overall elegance of this door.

## DOOR SIZE OPTIONS

PRODUCT DESCRIPTION	ADJUSTMENT SIZE		ACCESS	CODE
	MIN	MAX		
Sliding Quadrant 900mm <b>Left Hand</b>	870mm	890mm	500mm	OROSQ90LSC
Sliding Quadrant 900mm <b>Right Hand</b>	870mm	890mm	500mm	OROSQ90RSC
Sliding Quadrant 1000mm <b>Left Hand</b>	970mm	990mm	500mm	OROSQ100LSC
Sliding Quadrant 1000mm <b>Right Hand</b>	970mm	990mm	500mm	OROSQ100RSC

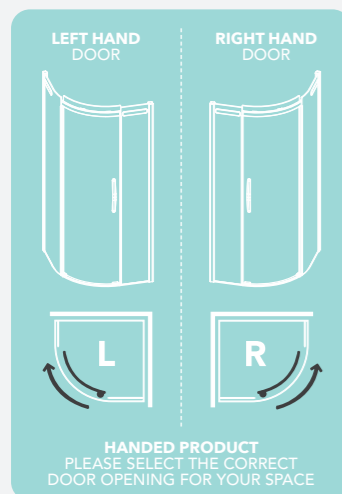

- 8mm TOUGHENED SAFETY GLASS
- 2000mm HEIGHT
- 20mm PROFILE ADJUSTMENT
- 10mm ULTRA LOW BOTTOM RAIL
- CRAFTED HANDLE DESIGN
- ULTRA CLEAR SEALS
- PATENTED MAGNETIC GUIDE SYSTEM
- CUSHION CLOSE DAMPENER MECHANISM
- CLEARVUE GLASS COATING





# SLIDING OFFSET QUADRANT DOOR

Generously proportioned, the ORO Sliding Offset Quadrant is designed to impress in your bathroom. The signature floating rail design cleverly encloses the rollers to give the door a sleek appearance.

Design excellence continues with the **patented magnetic guide system** ensuring the smoothest of motion as the door glides around the bottom rail. The **crafted chrome handles** have perfect symmetry, in line with the overall elegance of the door.

## DOOR SIZE OPTIONS

PRODUCT DESCRIPTION	ADJUSTMENT SIZE		ACCESS	CODE
	MIN	MAX		
Offset Sliding Quadrant 1000 x 800mm <b>Left Hand</b>	770-970mm	790-990mm	470mm	OROSQ80X100LSC
Offset Sliding Quadrant 1000 x 800mm <b>Right Hand</b>	770-970mm	790-990mm	470mm	OROSQ80X100RSC
Offset Sliding Quadrant 1000 x 900mm <b>Left Hand</b>	870-970mm	890-990mm	470mm	OROSQ90X100LSC
Offset Sliding Quadrant 1000 x 900mm <b>Right Hand</b>	870-970mm	890-990mm	470mm	OROSQ90X100RSC
Offset Sliding Quadrant 1200 x 800mm <b>Left Hand</b>	770-1170mm	790-1190mm	500mm	OROSQ80X120LSC
Offset Sliding Quadrant 1200 x 800mm <b>Right Hand</b>	770-1170mm	790-1190mm	500mm	OROSQ80X120RSC
Offset Sliding Quadrant 1200 x 900mm <b>Left Hand</b>	870-1170mm	890-1190mm	500mm	OROSQ90X120LSC
Offset Sliding Quadrant 1200 x 900mm <b>Right Hand</b>	870-1170mm	890-1190mm	500mm	OROSQ90X120RSC

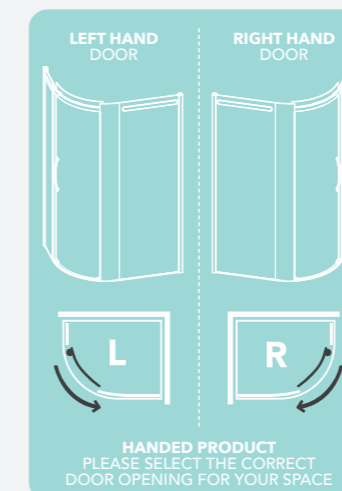

- 8mm TOUGHENED SAFETY GLASS
- 2000mm HEIGHT
- 20mm PROFILE ADJUSTMENT
- 10mm ULTRA LOW BOTTOM RAIL
- CRAFTED HANDLE DESIGN
- ULTRA CLEAR SEALS
- PATENTED MAGNETIC GUIDE SYSTEM
- SEAMLESS INTERIOR COVER STRIPS
- CUSHION CLOSE DAMPENER MECHANISM
- CLEARVUE GLASS COATING

ORO RIGHT HAND OFFSET SLIDING QUADRANT  
(to suit right hand offset quadrant shower tray)

---

CREATING  
PERFECT  
HARMONY

GEMSTONE

## GEMSTONE SLATE TEXTURED TRAYS

The Gemstone brand is synonymous with quality and style. This extensive selection of slate textured shower trays compliment the most beautiful of bathroom designs. With an ultra minimal height of 25 to 30mm, each tray is anti-slip rated and available in 4 colour options - Graphite Black, Flint Grey, White and the new Onyx Black.

Choose from square or linear shape waste options, with both chrome or colour matched grille finishes available depending on customer preference. Both visually appealing and sensual to touch, a Gemstone shower tray will work perfectly in a wide variety of bathroom applications, be they classic, modern or contemporary in design.





FLINT GREY TRAY WITH LINEAR WASTE

# GEMSTONE TRAYS

## KEY FEATURES

Slate texture – a natural stone resin composite with gel coat finish

Anti slip rated – Grade 3 Rating  
UNE ENV 12633:2003

Available in 4 colours – Onyx Black, White, Graphite Black & Flint Grey

Minimalist stainless steel waste cover in Square or Linear version

Colour matched interior waste trap  
(Graphite Black or Flint Grey Tray = Grey interior waste /  
White tray = White interior waste)

Supplied with 90mm McAlpine high flow waste

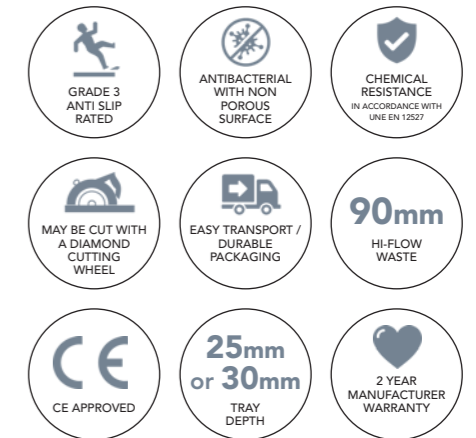

## GEMSTONE TRAY COLOUR OPTIONS

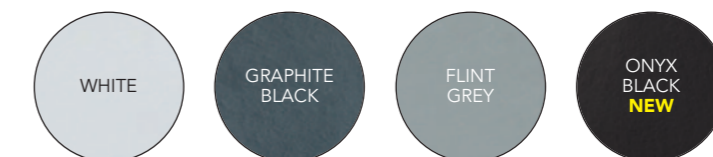

Note: Gemstone tray colours are reproduced as accurately as the printing process will allow. There is no guarantee of exact colour match - this brochure is a visual aid only.

# GEMSTONE

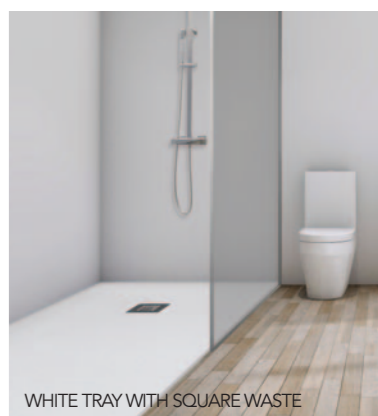

WHITE TRAY WITH SQUARE WASTE

## WASTE DESIGN - SQUARE WASTE

25mm  
TRAY  
DEPTH

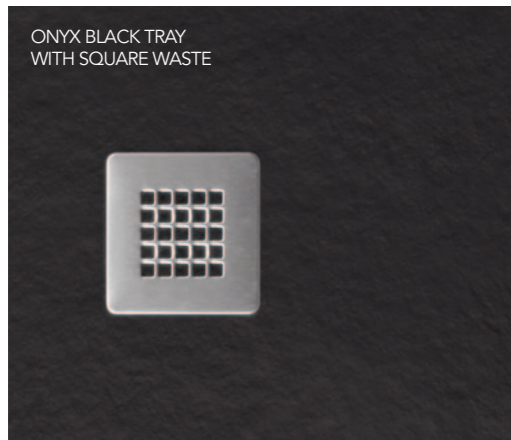

### SQUARE WASTE GRILL OPTION

- Available in Rectangle, Square, Quadrant and Offset Quadrant shapes

## COLOUR MATCHED GRILL OPTIONS

30mm  
TRAY  
DEPTH



### COLOUR MATCHED GRILL OPTION

- Choose to match your shower tray grill to the precise colour of your tray. Available in White, Graphite Black and Flint Grey

## WASTE DESIGN - LINEAR WASTE

30mm  
TRAY  
DEPTH

### LINEAR WASTE GRILL OPTION

- Defined gradient on linear tray
- On trend to create the minimalist wetroom look
- Rectangular shower tray shape only



## LINEAR WASTE

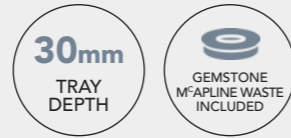

### RECTANGLE TRAY

PRODUCT DESCRIPTION	CODE
White Rectangular Tray 1200 x 800mm - Linear Waste	GEM12080RWL
Graphite Black Rectangular Tray 1200 x 800mm - Linear Waste	GEM12080RBL
Flint Grey Rectangular Tray 1200 x 800mm - Linear Waste	GEM12080RGL
White Rectangular Tray 1200 x 900mm - Linear Waste	GEM12090RWL
Graphite Black Rectangular Tray 1200 x 900mm - Linear Waste	GEM12090RBL
Flint Grey Rectangular Tray 1200 x 900mm - Linear Waste	GEM12090RGL
White Rectangular Tray 1400 x 800mm - Linear Waste	GEM14080RWL
Graphite Black Rectangular Tray 1400 x 800mm - Linear Waste	GEM14080RBL
Flint Grey Rectangular Tray 1400 x 800mm - Linear Waste	GEM14080RGL
White Rectangular Tray 1400 x 900mm - Linear Waste	GEM14090RWL
Graphite Black Rectangular Tray 1400 x 900mm - Linear Waste	GEM14090RBL
Flint Grey Rectangular Tray 1400 x 900mm - Linear Waste	GEM14090RGL
White Rectangular Tray 1500 x 800mm - Linear Waste	GEM15080RWL
Graphite Black Rectangular Tray 1500 x 800mm - Linear Waste	GEM15080RBL
Flint Grey Rectangular Tray 1500 x 800mm - Linear Waste	GEM15080RGL
White Rectangular Tray 1500 x 900mm - Linear Waste	GEM15090RWL
Graphite Black Rectangular Tray 1500 x 900mm - Linear Waste	GEM15090RBL
Flint Grey Rectangular Tray 1500 x 900mm - Linear Waste	GEM15090RGL
White Rectangular Tray 1600 x 800mm - Linear Waste	GEM16080RWL
Graphite Black Rectangular Tray 1600 x 800mm - Linear Waste	GEM16080RBL
Flint Grey Rectangular Tray 1600 x 800mm - Linear Waste	GEM16080RGL
White Rectangular Tray 1600 x 900mm - Linear Waste	GEM16090RWL
Graphite Black Rectangular Tray 1600 x 900mm - Linear Waste	GEM16090RBL
Flint Grey Rectangular Tray 1600 x 900mm - Linear Waste	GEM16090RGL
White Rectangular Tray 1700 x 700mm - Linear Waste	GEM17070RWL
Graphite Black Rectangular Tray 1700 x 700mm - Linear Waste	GEM17070RBL
Flint Grey Rectangular Tray 1700 x 700mm - Linear Waste	GEM17070RGL
White Rectangular Tray 1700 x 800mm - Linear Waste	GEM17080RWL
Graphite Black Rectangular Tray 1700 x 800mm - Linear Waste	GEM17080RBL
Flint Grey Rectangular Tray 1700 x 800mm - Linear Waste	GEM17080RGL

Flow rate 24 l/min when tested under a constant 15mm head of water, in accordance with clause 5 of BS EN 274-2:2002

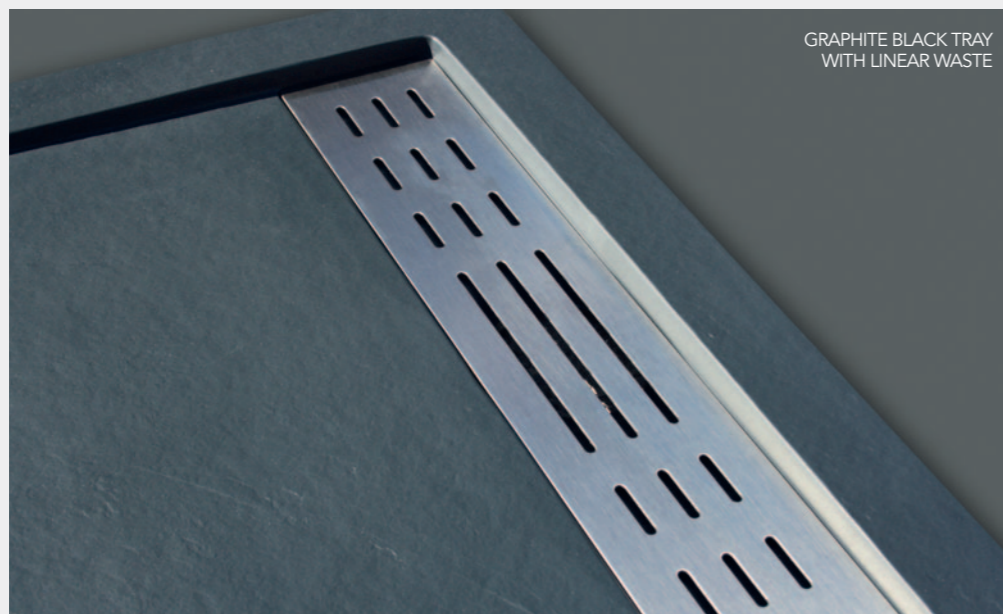

GRAPHITE BLACK TRAY WITH LINEAR WASTE

## SQUARE WASTE



### SQUARE TRAY

PRODUCT DESCRIPTION	CODE
White Square Tray 900mm - Square Waste	GEM90SWS
Graphite Black Square Tray 900mm - Square Waste	GEM90SBS
Flint Grey Square Tray 900mm - Square Waste	GEM90SGS
Onyx Black Square Tray 900mm - Square Waste	GEM90SOS
White Square Tray 1000mm - Square Waste	GEM100SWS
Graphite Black Square Tray 1000mm - Square Waste	GEM100SBS
Flint Grey Square Tray 1000mm - Square Waste	GEM100SGS

### QUADRANT TRAY

PRODUCT DESCRIPTION	CODE
White Quadrant Tray 900mm - Square Waste	GEM90QWS
Graphite Black Quadrant Tray 900mm - Square Waste	GEM90QBS
Flint Grey Quadrant Tray 900mm - Square Waste	GEM90QGS
Onyx Black Quadrant Tray 900mm - Square Waste	GEM90QOS
White Quadrant Tray 1000mm - Square Waste	GEM100QWS
Graphite Black Quadrant tray 1000mm - Square Waste	GEM100QBS
Flint Grey Quadrant Tray 1000mm - Square Waste	GEM100QGS

### OFFSET QUADRANT TRAY

PRODUCT DESCRIPTION	CODE
White Offset Quadrant Tray 1000 x 800mm LEFT HAND - Square Waste	GEM10080QWSL
White Offset Quadrant Tray 1000 x 800mm RIGHT HAND - Square Waste	GEM10080QWSR
Graphite Black Offset Tray 1000 x 800mm LEFT HAND - Square Waste	GEM10080QBSL
Graphite Black Offset Tray 1000 x 800mm RIGHT HAND - Square Waste	GEM10080QBRS
Flint Grey Offset Quadrant Tray 1000 x 800mm LEFT HAND - Square Waste	GEM10090QGSL
Flint Grey Offset Quadrant Tray 1000 x 800mm RIGHT HAND - Square Waste	GEM10080QGSR
White Offset Quadrant Tray 1200 x 800mm LEFT HAND - Square Waste	GEM12080QWSL
White Offset Quadrant Tray 1200 x 800mm RIGHT HAND - Square Waste	GEM12080QWSR
Graphite Black Offset Tray 1200 x 800mm LEFT HAND - Square Waste	GEM12080QBSL
Graphite Black Offset Tray 1200 x 800mm RIGHT HAND - Square Waste	GEM12080QBRS
Flint Grey Offset Quadrant Tray 1200 x 800mm LEFT HAND - Square Waste	GEM12080QGSL
Flint Grey Offset Quadrant Tray 1200 x 800mm RIGHT HAND - Square Waste	GEM12080QGSR
Onyx Black Black Offset Tray 1200 x 800mm LEFT HAND - Square Waste	GEM12080QOSL
Onyx Black Offset Tray 1200 x 800mm RIGHT HAND - Square Waste	GEM12080QOSR
White Offset Quadrant Tray 1200 x 900mm LEFT HAND - Square Waste	GEM12090QWSL
White Offset Quadrant Tray 1200 x 900mm RIGHT HAND - Square Waste	GEM12090QWSR
Graphite Black Offset Tray 1200 x 900mm LEFT HAND - Square Waste	GEM12090QBSL
Graphite Black Offset Tray 1200 x 900mm RIGHT HAND - Square Waste	GEM12090QBRS
Flint Grey Offset Quadrant Tray 1200 x 900mm LEFT HAND - Square Waste	GEM12090QGSL
Flint Grey Offset Quadrant Tray 1200 x 900mm RIGHT HAND - Square Waste	GEM12090QGSR
Onyx Black Black Offset Tray 1200 x 900mm LEFT HAND - Square Waste	GEM12090QOSL
Onyx Black Offset Tray 1200 x 900mm RIGHT HAND - Square Waste	GEM12090QOSR

## SQUARE WASTE

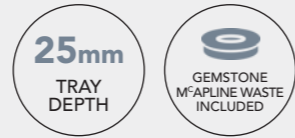

### RECTANGLE TRAY

PRODUCT DESCRIPTION	CODE
White Rectangular Tray 1000 x 800mm - Square Waste	GEM10080RWS
Graphite Black Rectangular Tray 1000 x 800mm - Square Waste	GEM10080RBS
Flint Grey Rectangular Tray 1000 x 800mm - Square Waste	GEM10080RGS
Onyx Black Rectangular Tray 1000 x 800mm - Square Waste	GEM10080ROS
White Rectangular Tray 1000 x 900mm - Square Waste	GEM10090RWS
Graphite Black Rectangular Tray 1000 x 900mm - Square Waste	GEM10090RBS
Flint Grey Rectangular Tray 1000 x 900mm - Square Waste	GEM10090RGS
Onyx Black Rectangular Tray 1000 x 900mm - Square Waste	GEM10090ROS
White Rectangular Tray 1100 x 800mm - Square Waste	GEM11080RWS
Graphite Black Rectangular Tray 1100 x 800mm - Square Waste	GEM11080RBS
Flint Grey Rectangular Tray 1100 x 800mm - Square Waste	GEM11080RGS
White Rectangular Tray 1100 x 900mm - Square Waste	GEM11090RWS
Graphite Black Rectangular Tray 1100 x 900mm - Square Waste	GEM11090RBS
Flint Grey Rectangular Tray 1100 x 900mm - Square Waste	GEM11090RGS
White Rectangular Tray 1200 x 800mm - Square Waste	GEM12080RWS
Graphite Black Rectangular Tray 1200 x 800mm - Square Waste	GEM12080RBS
Flint Grey Rectangular Tray 1200 x 800mm - Square Waste	GEM12080RGS
Onyx Black Rectangular Tray 1200 x 800mm - Square Waste	GEM12080ROS
White Rectangular Tray 1200 x 900mm - Square Waste	GEM12090RWS
Graphite Black Rectangular Tray 1200 x 900mm - Square Waste	GEM12090RBS
Flint Grey Rectangular Tray 1200 x 900mm - Square Waste	GEM12090RGS
Onyx Black Rectangular Tray 1200 x 900mm - Square Waste	GEM12090ROS
White Rectangular Tray 1400 x 800mm - Square Waste	GEM14080RWS
Graphite Black Rectangular Tray 1400 x 800mm - Square Waste	GEM14080RBS
Flint Grey Rectangular Tray 1400 x 800mm - Square Waste	GEM14080RGS
Onyx Black Rectangular Tray 1400 x 800mm - Square Waste	GEM14080ROS
White Rectangular Tray 1400 x 900mm - Square Waste	GEM14090RWS
Graphite Black Rectangular Tray 1400 x 900mm - Square Waste	GEM14090RBS
Flint Grey Rectangular Tray 1400 x 900mm - Square Waste	GEM14090RGS
Onyx Black Rectangular Tray 1400 x 900mm - Square Waste	GEM14090ROS
White Rectangular Tray 1500 x 800mm - Square Waste	GEM15080RWS
Graphite Black Rectangular Tray 1500 x 800mm - Square Waste	GEM15080RBS
Flint Grey Rectangular Tray 1500 x 800mm - Square Waste	GEM15080RGS
White Rectangular Tray 1500 x 900mm - Square Waste	GEM15090RWS
Graphite Black Rectangular Tray 1500 x 900mm - Square Waste	GEM15090RBS
Flint Grey Rectangular Tray 1500 x 900mm - Square Waste	GEM15090RGS
White Rectangular Tray 1600 x 800mm - Square Waste	GEM16080RWS
Graphite Black Rectangular Tray 1600 x 800mm - Square Waste	GEM16080RBS
Flint Grey Rectangular Tray 1600 x 800mm - Square Waste	GEM16080RGS
Onyx Black Rectangular Tray 1600 x 800mm - Square Waste	GEM16080ROS
White Rectangular Tray 1600 x 900mm - Square Waste	GEM16090RWS
Graphite Black Rectangular Tray 1600 x 900mm - Square Waste	GEM16090RBS
Flint Grey Rectangular Tray 1600 x 900mm - Square Waste	GEM16090RGS
Onyx Black Rectangular Tray 1600 x 900mm - Square Waste	GEM16090ROS

## SQUARE WASTE

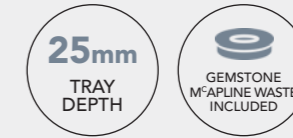

### RECTANGLE TRAY

PRODUCT DESCRIPTION	CODE
White Rectangular Tray 1700 x 700mm - Square Waste	GEM17070RWS
Graphite Black Rectangular Tray 1700 x 700mm - Square Waste	GEM17070RBS
Flint Grey Rectangular Tray 1700 x 700mm - Square Waste	GEM17070RGS
White Rectangular Tray 1700 x 800mm - Square Waste	GEM17080RWS
Graphite Black Rectangular Tray 1700 x 800mm - Square Waste	GEM17080RBS
Flint Grey Rectangular Tray 1700 x 800mm - Square Waste	GEM17080RGS
Onyx Black Rectangular Tray 1700 x 800mm - Square Waste	GEM17080ROS
White Rectangular Tray 1700 x 900mm - Square Waste	GEM17090RWS
Graphite Black Rectangular Tray 1700 x 900mm - Square Waste	GEM17090RBS
Flint Grey Rectangular Tray 1700 x 900mm - Square Waste	GEM17090RGS
Onyx Black Rectangular Tray 1700 x 900mm - Square Waste	GEM17090ROS
White Rectangular Tray 1800 x 800mm - Square Waste	GEM18080RWS
Graphite Black Rectangular Tray 1800 x 800mm - Square Waste	GEM18080RBS
Flint Grey Rectangular Tray 1800 x 800mm - Square Waste	GEM18080RGS
White Rectangular Tray 1800 x 900mm - Square Waste	GEM18090RWS
Graphite Black Rectangular Tray 1800 x 900mm - Square Waste	GEM18090RBS
Flint Grey Rectangular Tray 1800 x 900mm - Square Waste	GEM18090RGS



GEMSTONE TRAY,  
COUNTERSUNK WITH A  
FLUSH TO FLOOR FINISH

## COLOUR MATCHED WASTE GRILLS

### COLOURED GRILLS

PRODUCT DESCRIPTION	CODE
Gemstone Grill 70mm - Linear Black	GEMG70LB
Gemstone Grill 70mm - Linear Chrome	GEMG70LC
Gemstone Grill 70mm - Linear Grey	GEMG70LG
Gemstone Grill 70mm - Linear White	GEMG70LW
Gemstone Grill 80mm - Linear Black	GEMG80LB
Gemstone Grill 80mm - Linear Chrome	GEMG80LC
Gemstone Grill 80mm - Linear Grey	GEMG80LG
Gemstone Grill 80mm - Linear White	GEMG80LW
Gemstone Grill 90mm - Linear Black	GEMG90LB
Gemstone Grill 90mm - Linear Chrome	GEMG90LC
Gemstone Grill 90mm - Linear Grey	GEMG90LG
Gemstone Grill 90mm - Linear White	GEMG90LW
Gemstone Grill Square - Black	GEMGSB
Gemstone Grill Square - Chrome	GEMGSC
Gemstone Grill Square - Grey	GEMGSG
Gemstone Grill Square - White	GEMGSW

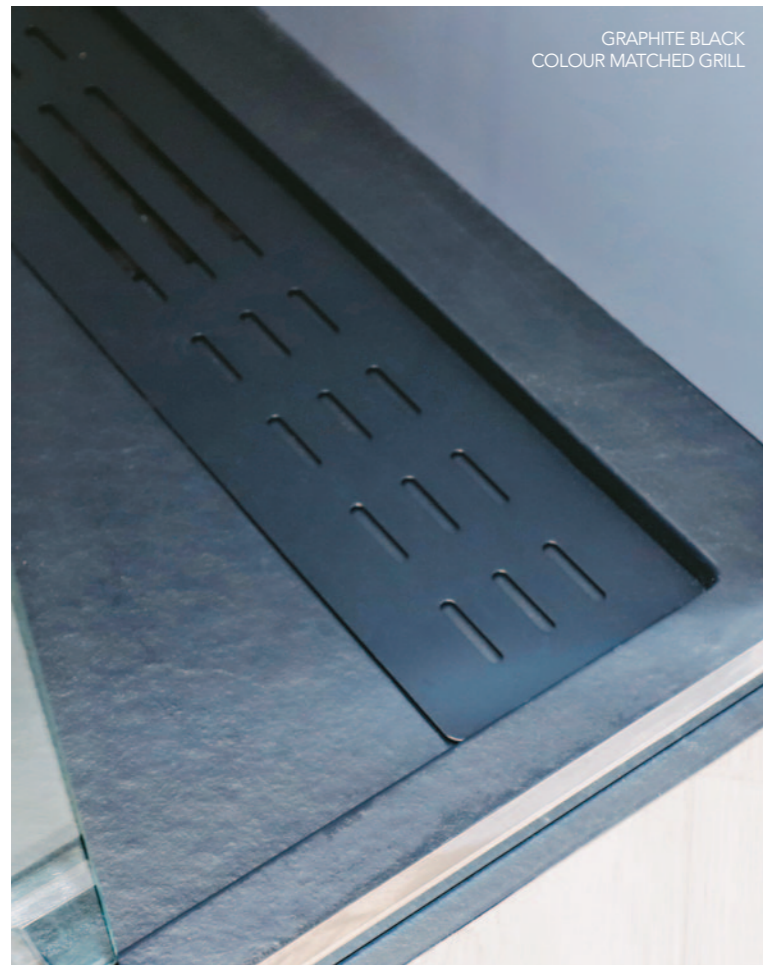

GRAPHITE BLACK  
COLOUR MATCHED GRILL



WHITE COLOUR  
MATCHED GRILL



## GEMSTONE INFORMATION

### GUARANTEE

Your Gemstone tray must be inspected 100% before installation. Fitting of tray is acceptance of quality. Please read fitting instructions fully before installation.

Before tiling and placing the screen or any other fixed material on the shower tray, please make sure that the perimeters of your tray are 100% level in all directions.

The guarantee only covers the replacement or repair of the product and excludes any other compensation, assembly or travel costs.

Gemstone Trays are guaranteed for 2 years, in accordance with current European regulations.

**The following are excluded from the guarantee:**

- Damage caused by misuse
- Damage caused by the use of unsuitable cleaning materials (do not use products containing acids, alcohol, chlorine or solvents, do not spill drain cleaners onto the shower tray, do not use metallic or scouring pads)
- Damage caused by improper installation
- Damage caused by the improper handling of the product

Our products must be installed by qualified personnel to be eligible for the product guarantee. An installation guide will be delivered with the tray for its proper placement.

**Before installing the tray you should make sure that:**

- The tray drains well and is 100% level
- It has no anomalies
- **The tray has been stored in a horizontal position, on a flat surface, until installation**

### CLEANING

- Routine: rinse and leave to dry
- Thorough: rub with a soft cloth with neutral liquid detergent; for limescale prevention use an anti-lime product

**Please note, Gemstone Trays are manufactured from a natural stone resin composition. You must allow for a tray thickness tolerance of 2 - 3mm.**

### CHEMICAL TESTS

Chemical resistance tested in accordance with UNE-EN 12527 - No deterioration.

### CHEMICAL TESTING COMPOSITION

Acetyl acid (10%), sodium hydroxide (10%), ethanol (70%), bleach, methylene blue (1%).

CLEANING SOLVENT (PRODUCT)	EXPOSURE TIME (DAYS)	RESULT OF VISUAL INSPECTION
Don Limpio Neutral PH	4	No Visible Effect
Perfumed Home Bleach	4	Slight Bleaching
Ace	4	Slight Bleaching
Perfumed Ammonia	4	No Visible Effect
Viakal	4	Slight Bleaching
Cillit Bang	4	No Visible Effect
KH-7 Anti-lime	4	No Visible Effect
White Wine Vinegar	4	No Visible Effect
Povidone Iodine	4	No Visible Effect
Hydrochloric Acid	4	No Visible Effect
Hydrogen Peroxide	4	No Visible Effect
Cleaning Solvent	4	No Visible Effect
Methylated Spirits	4	No Visible Effect
Acetone	4	No Visible Effect
Nail Polish Remover	4	No Visible Effect

### PACKAGING AND STORAGE

The products are delivered packed in individual boxes with expanded polystyrene reinforcements, including the drainage grate. **Gemstone trays must be stored in a horizontal position on a flat surface until installation. This prevents the tray from losing shape.**

### FAQ

**Can it be cut?**

Yes, with a diamond cutting wheel.

**Can it be repaired?**

Although they are highly resistant to any impact, we have a repair kit available to the customer. Please contact us on 00353 42 966 8000 to order your Gemstone Tray repair kit. Lead time applies.

**How should the product be cleaned?**

We recommend cleaning with water and neutral soap, applied with a sponge, never with scouring products or tools.

**What material should I use to install the products?**

Your Gemstone tray must be installed on a fully level glue-cement or mortar base. For sealing the product, it is recommended to use MS flexible polyurethane sealant and / or a neutral silicone.



# ORO<sup>®</sup> DOOR STYLES & HANDED DOOR GUIDE

## HINGED QUADRANT DOOR

Please select carefully the ORO Hinged Quadrant that is the correct hand opening for your space.

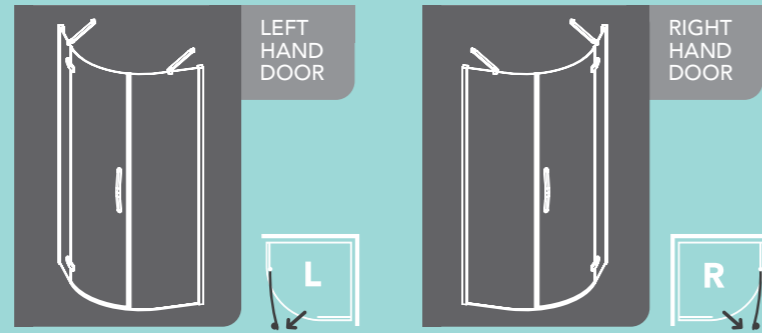

## HINGED OFFSET QUADRANT DOOR

Please select carefully the ORO Hinged Offset Quadrant that is the correct shape for your offset shower tray.

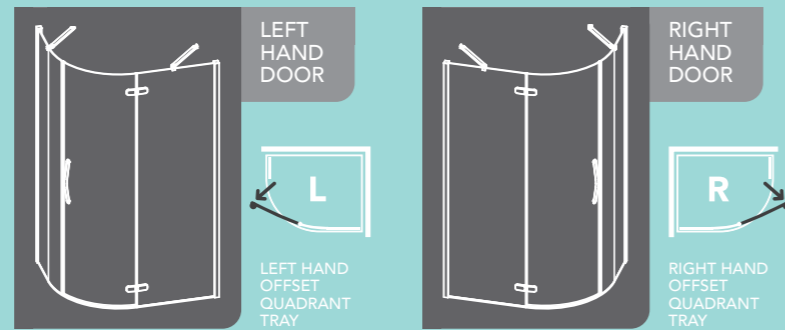

## SLIDING QUADRANT DOOR

Please select carefully the ORO Sliding Quadrant that is the correct hand opening for your space.

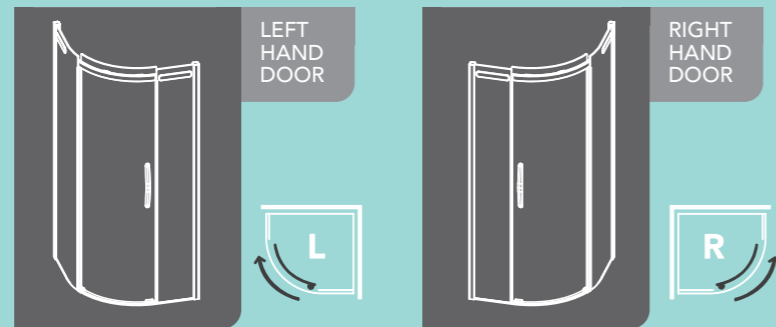

## SLIDING OFFSET QUADRANT DOOR

Please select carefully the ORO Sliding Offset Quadrant that is the correct shape for your offset shower tray.

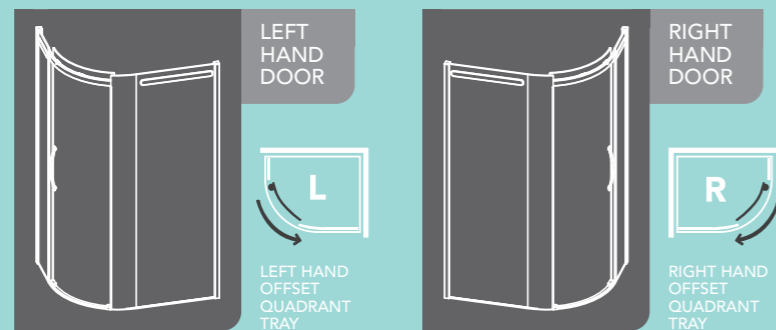

## SLIDER DOOR

Please select carefully the ORO Slider Door that is the correct hand opening for your space.



## HINGED DOOR

The ORO Hinged Door is universal, so it can be adapted at installation to suit either left or right hand installation.

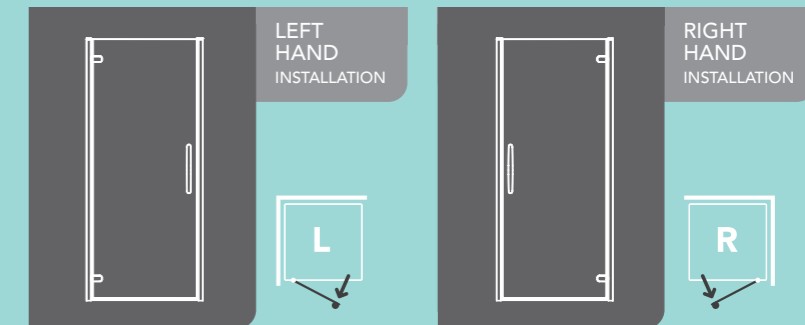

## HINGED AND INLINE DOOR

Please select carefully the ORO Hinge and Inline Door that is the correct hand opening for your space.

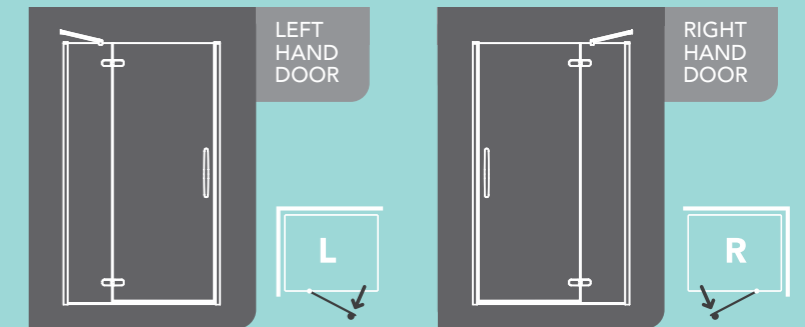

## BI-FOLD DOOR

The ORO Bi-Fold Door is universal, so it can be adapted at installation to suit either left or right hand installation.

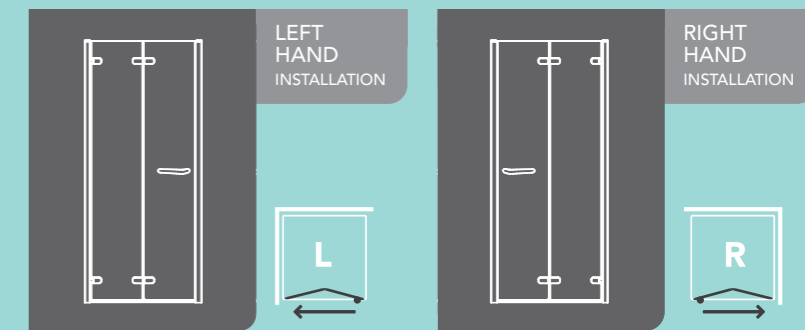

# ORO<sup>®</sup> WATER RETENTION GUIDE

ORO Sliding Doors have a new award winning design that reduces the need for invasive seals or large bottom rails allowing the customer a unique frameless showering experience.

As standard, ORO Sliding Doors come with a minimalist bottom barrier bar that does not include the use of an invasive seal or large bottom rail as part of the frameless design.

The ORO enclosure range is tested and certified for water retention in accordance with EN14428 where conventional showering practices are used and the product has been fitted in accordance with the Flair Fitting Instructions.

However, in unconventional showering practices, to further improve water retention and minimise any water escaping from the shower enclosure we have designed additional water retention solutions for optional use by customers.

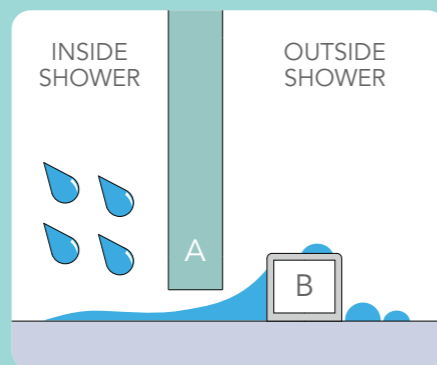

A - Sliding Door Glass  
B - Minimal Barrier Bar

## OPTION 1 THRESHOLD SEAL

The ORO Threshold seal is a minimal 15mm high silver profile with a discreet clear seal that can be easily fitted on top of the barrier bar during or after installation.

The Threshold seal will provide an increased level of water retention and protect against large surges of water escaping from the shower area. ORO Threshold seals are readily available from Flair Showers and can be ordered using the below product codes.

**Product Codes:**

S-OROSA110TSS, S-ORO120TSS,  
S-OROSA140-160TSS, S-OROSQTSS

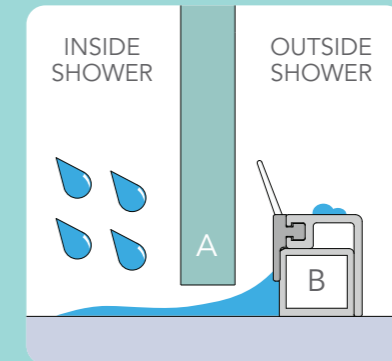

A - Sliding Door Glass  
B - Minimal Barrier Bar  
I - Threshold Seal



## OPTION 2 THRESHOLD BARRIER BAR

The ORO Threshold Barrier Bar is a larger 27mm high barrier bar which can be easily fitted on top of the barrier bar during or after installation.

The Threshold Barrier Bar offers the highest level of water retention available in the ORO Frameless Sliding Door's design.

ORO Threshold Barrier Bars are readily available from Flair Showers and can be ordered using the below product codes.

**Product Codes:**

S-OROSA110TBS, S-ORO120TBS,  
S-OROSA140-160TBS, S-OROSQTBS

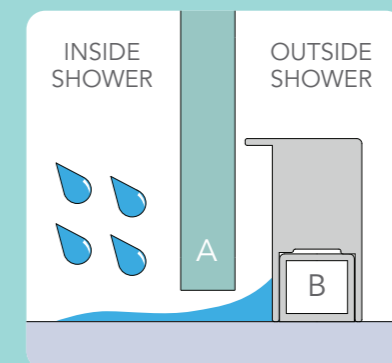

A - Sliding Door Glass  
B - Minimal Barrier Bar  
2 - Threshold Bar



# DESIGNED FOR LIFE



SINCE  
1952

flair  
—

Founded in County Cavan in 1952, Flair have built up a trusted reputation as a specialist in the production of quality shower doors and bath screens. Our reputation has stood the test of time, making us the oldest manufacturer of our kind in Ireland. We are proud to be a brand of choice for customers.

With an unwavering commitment to customer care, Flair combine lifelong knowledge and expertise with advanced production techniques. We offer our customers innovative designs that bring a new sense of enrichment to their bathroom and enjoyment to our customers.

The perfect blend of function and form. Designed for life.



---

# COMMERCIAL PROJECTS



## GRAND CENTRAL, BELFAST

The Grand Central Hotel is at the heart of Belfast City. Set in the Linen Quarter with 300 bedrooms designed for absolute comfort and relaxation.



## MARIANELLA, DUBLIN

Marianella is a flagship development of the finest new apartments and houses in stunningly landscaped grounds in Rathgar, Dublin.



## RADISSON BLU HOTEL, ATHLONE

A fantastic waterfront hotel, with scenic views over the river and town. Radisson Blu Hotels are designed to ensure that guests enjoy a truly memorable experience.

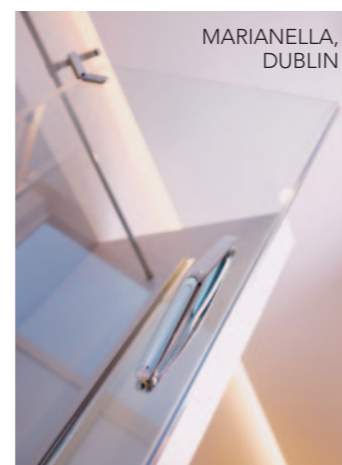

GRAND CENTRAL HOTEL,  
BELFAST



# QUALITY GUARANTEED

## At Flair we have an unwavering commitment to product quality.

All ORO Shower Doors are CE approved and manufactured in accordance with ISO 9001:2000 Quality Assurance systems. All glass is toughed safety glass and produced to EN12150.

Flair products are performance tested to EN14428. This means that ORO Shower Enclosures have been subject to lifetime shower cycle testing consisting of 20,000 functional cycles, water tests, impact tests and 10,000 corrosion cycle tests for all components. ORO Doors are also tested for their durability, stability and water retention properties to ensure that they meet the highest possible industry standards. Please note - Due to the weight of this product it requires a two man lift.

### INSTALLATION

Full installation instructions are provided with each ORO product to ensure correct installation. ORO Shower Doors and Side Panels are adjustable between the dimensions stated. All dimensions are approximate.

## ORO Lifetime Guarantee.

ORO Shower Doors are covered by a lifetime guarantee against manufacturer defect. This guarantee is valid on the condition that goods are installed and maintained in accordance with the products fitting instructions and best practices. **\*Note: Non glass and detachable parts such as rollers, seals, door dampeners and cover caps are subject to normal wear and tear during usage and are under statutory guarantee for 2 years from time of purchase.**

We ask our customers to register their guarantee online at [www.flairshowers.com](http://www.flairshowers.com) or return the guarantee card that comes with every ORO door.

## Aftersales & Spare Parts service

Flair is 100% committed to customer service excellence. We carry a full range of spare parts for each of our product ranges and have dedicated aftersales representatives to deal with any issues you may have.

If you would like to talk to our customer aftercare team, please contact us on +353 42 966 8000.

### CONDITIONS OF SALE

Unless otherwise stated, all price quotations are subject to acceptance within 30 days of date of issue. Other than in the case of faulty goods / incorrect despatch, Flair will not accept the return of any product.

AS PART OF OUR CONTINUING POLICY OF PRODUCT IMPROVEMENT, WE RESERVE THE RIGHT TO AMEND SPECIFICATIONS, COLOURS AND PRICES WITHOUT PRIOR NOTICE.

\*Errors and Omissions Exempt.

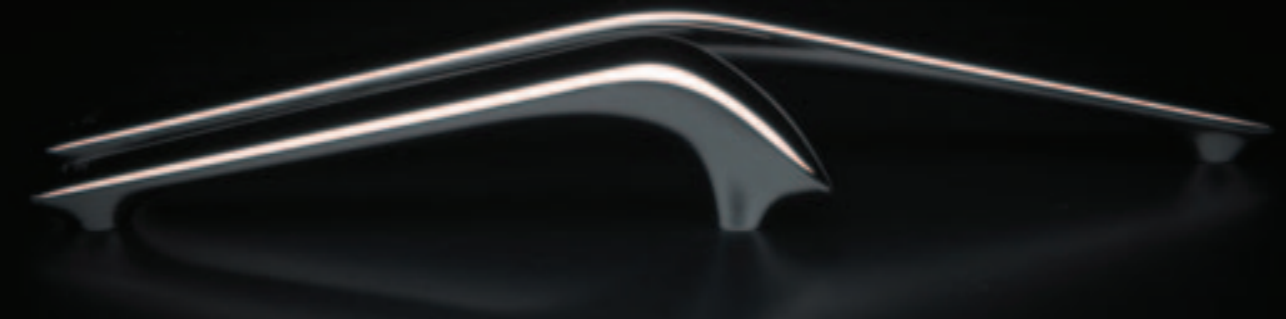

HAND CRAFTED ORO  
HANDLE DESIGN



MAY 2021

# DESIGNED FOR LIFE

Flair Showers Ltd.  
Rocks Road  
Kingscourt  
Co Cavan  
Ireland

T +353 42 966 8000  
E sales@flairshowers.com

Connect with us



FLAIRSHOWERS.COM