

---

SIDE PANEL  
INSTALLATION GUIDE  
INSTRUCTIONS DE MONTAGE  
GUIDA ALL'INSTALLAZIONE

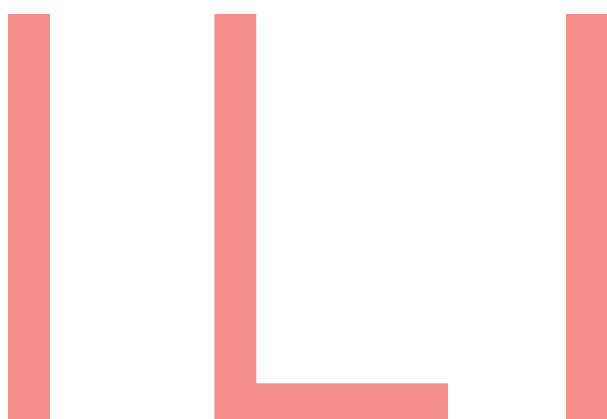

flair  
—

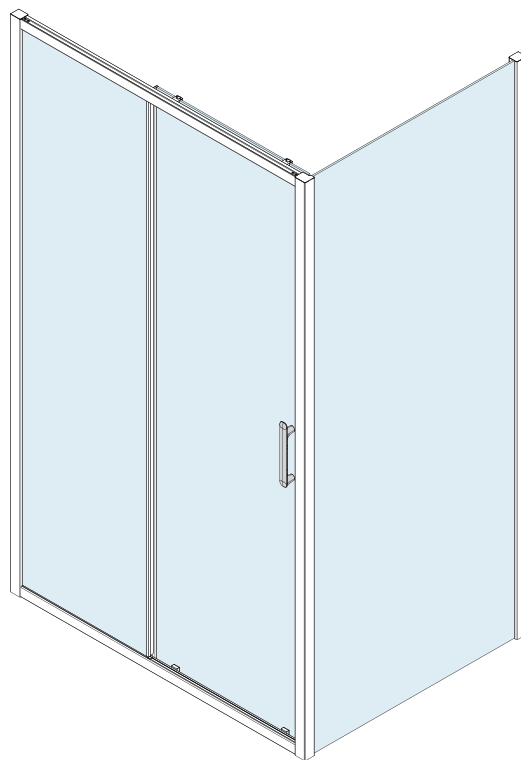

SINCE  
1952

flair  
—



**Thank you for purchasing your ILI  
shower door from Flair Showers Ltd.**

We wish you many years of enjoyment using it.  
The ILI range offers craftsmanship you can feel  
and reliability you can count on.

Your bathroom is a personal affair - we hope  
that your ILI shower door brings a new sense  
of enrichment and enjoyment to your life.

The perfect blend of function and form –  
Designed for Life.



---

## QUALITY GUARANTEED

At Flair we have an unwavering commitment to product quality.

ILI shower doors are covered by a lifetime guarantee against manufacturer defect. This guarantee is valid on the condition that goods are installed and maintained in accordance with the products fitting instructions and best practices.

Non glass and detachable parts such as rollers, seals etc. are subject to normal wear and tear during usage and are under guarantee for 12 months from time of purchase.

Please complete your product guarantee card included in the components box or register online at [flairshowers.com/register](http://flairshowers.com/register).

All Flair products are CE/UKCA approved. All glass is toughened safety glass and produced to EN12150. Flair products are performance tested to EN14428, ensuring the highest industry criteria is met.

## AFTERSALES & SPARE PARTS SERVICE

Flair is 100% committed to customer service excellence.

We carry a full range of spare parts for each of our product ranges and have dedicated aftersales representatives to deal with any issues you may have.

If you would like to talk to our customer aftercare team, please contact us on 042 966 8000.

## WARNING!

BEFORE YOU INSTALL YOUR SHOWER DOOR PLEASE READ ALL INSTRUCTION FAILURE TO DO SO MAY LEAD TO INVALIDATION OF YOUR WARRANTY.

Check that your product size is compatible to the installation site.  
Ensure the tray is 100% level.  
Check all components  
Check installation kit is complete and matches the "In the box section" of this instruction.

# IN THE BOX

TAKE A MINUTE TO CHECK THE  
CONTENTS OF EACH BOX

---

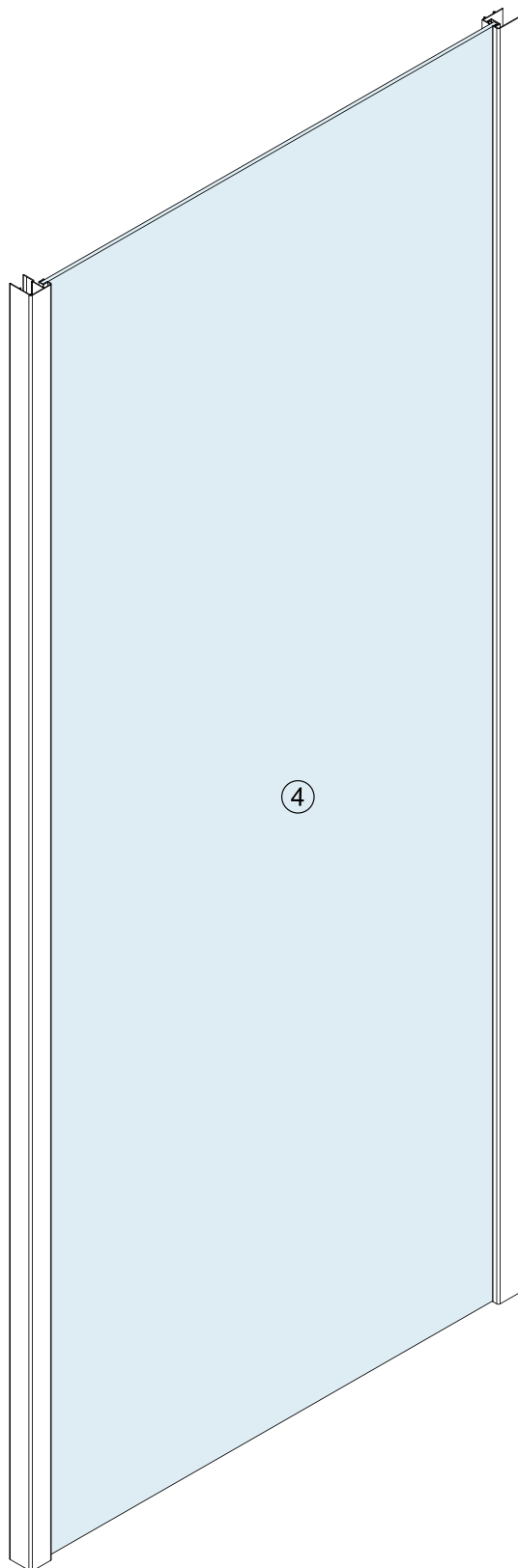

①



L=1950mm  
S-ILISPCS  
Aluminium Cover Strip x 1

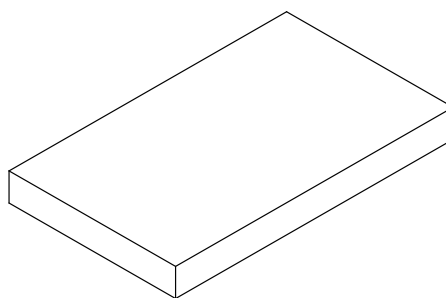

Component Pack

# COMPONENTS AND TOOLS

WHAT'S IN YOUR COMPONENT PACK AND THE TOOLS YOU WILL NEED ON HAND TO FIT YOUR ILI SHOWER DOOR

---



Out of the Box

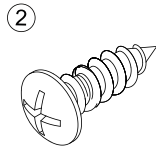

ST4x10mm  
x3

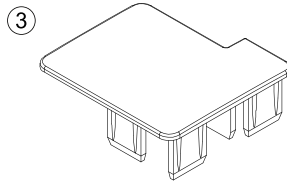

Wall Jamb Top  
Cap Set-L  
x1

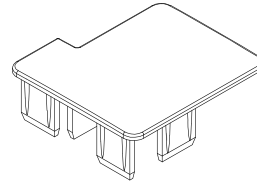

Wall Jamb Top  
Cap Set-R  
x1



Tool Kit



Silicone Gun



Drill



6mm Drill Bit



Hammer



Spirit Level



Measuring Tape



Allen Key



Screwdriver



Bin

# MEET THE ILI SIDE PANEL

ALL PARTS SHOWN BELOW ARE FOR ASSEMBLY

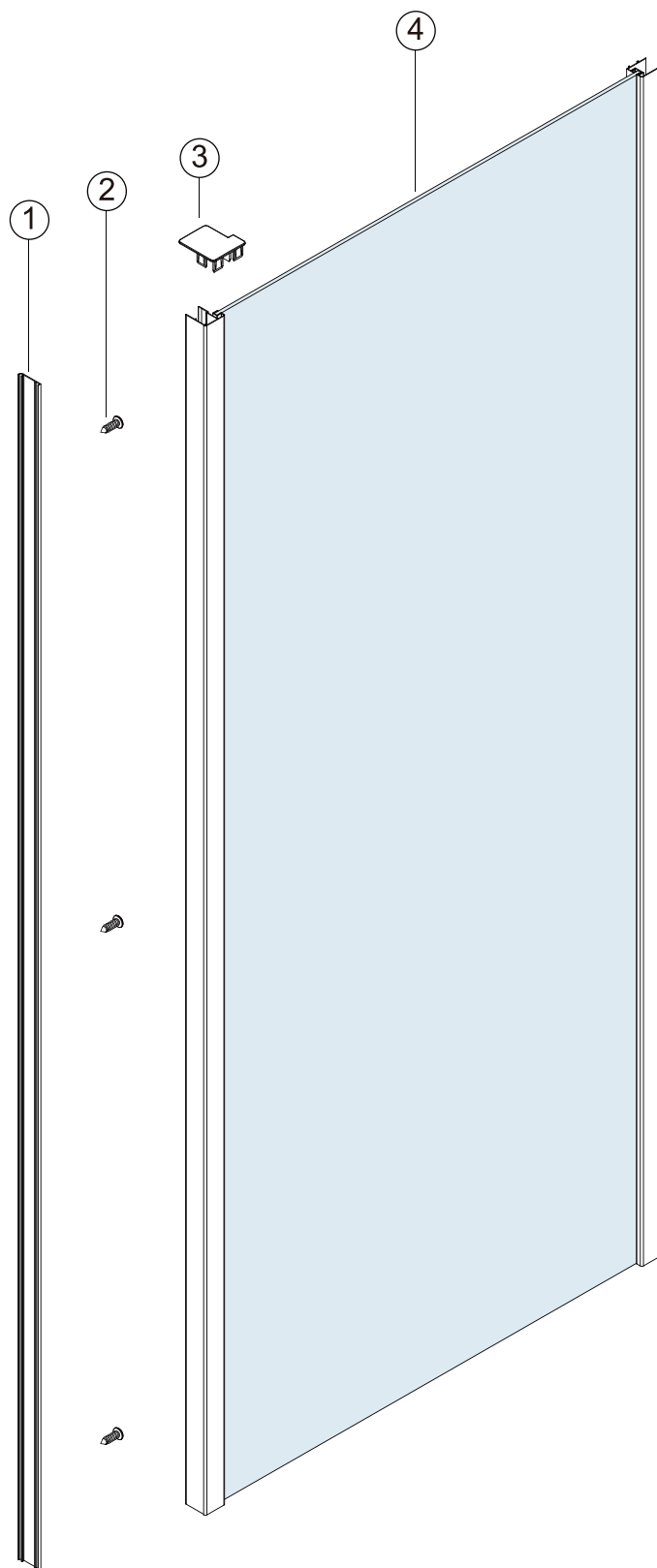

Article No.	Qty	Description	Part No.	Article No.	Qty	Description	Part No.
①	1	Aluminium Cover Strip	S-ILISPCS	③	2	Wall Jamb Top Cap Set	S-ILISPCPTC
②	3	ST4x10mm Screw	S-ILISPSP	④	1	Side Panel	A

ILI

FR

**Merci d'avoir choisi votre panneau latéral III  
chez Flair Showers Ltd.**

Nous espérons que vous apprécierez ce produit pendant de nombreuses années. Notre gamme ILI offre un savoir-faire remarquable et une fiabilité sur laquelle vous pouvez compter.

Votre salle de bain est un lieu de relaxation personnel, avec ILI nous espérons que votre douche apporte satisfaction et plaisir dans votre vie.

La combinaison parfaite de la fonctionnalité et du style - DESIGNED FOR LIFE.



---

## GARANTIE DE QUALITÉ

Chez Flair, nous avons un engagement indéfectible à la qualité des produits.

Les portes de douche ILLI sont couvertes par une garantie à vie contre tous les défauts de fabrication. Cette garantie est valable à condition que les produits soient installés et entretenus en accord avec les instructions recommandées par FLAIR.

Les parties non en verre et amovibles telles que les joints etc. sont soumises à usure normale durant leur usage et sont garanties 12 mois à compter de la date d'achat.

Tous les produits Flair sont certifiés CE/UKCA, avec un verre de sécurité trempé, selon la norme EN12150. Les produits Flair sont soumis à des tests de performance selon la norme EN 14428, garantissant le respect des critères les plus élevés de l'industrie.

## SERVICE APRÈS VENTE ET PIÈCES DÉTACHÉES

Flair est engagé à 100% au service de sa clientèle.

Nous disposons d'un stock complet de pièces détachées pour chacun de nos produits et nos techniciens du service après-vente peuvent étudier tout problème éventuel.

Veuillez nous contacter par téléphone au +353 42 969 4436 ou par email à [ventes@flairshowers.com](mailto:ventes@flairshowers.com).

## ATTENTION:

**AVANT D'INSTALLER VOTRE PORTE DE DOUCHE, LIRE ATTENTIVEMENT TOUTES LES INSTRUCTIONS. LE NON RESPECT DE CETTE CONSIGNE ANNULERA LA GARANTIE DE VOTRE PRODUIT.**

Vérifiez tous les composants. Vérifiez que le kit d'installation soit complet et corresponde à la section "DANS LE CARTON" de ces instructions.

# DANS LE CARTON

MERCI DE PRENDRE LE TEMPS DE VÉRIFIER  
LE CONTENU DE CHAQUE BOÎTE

---

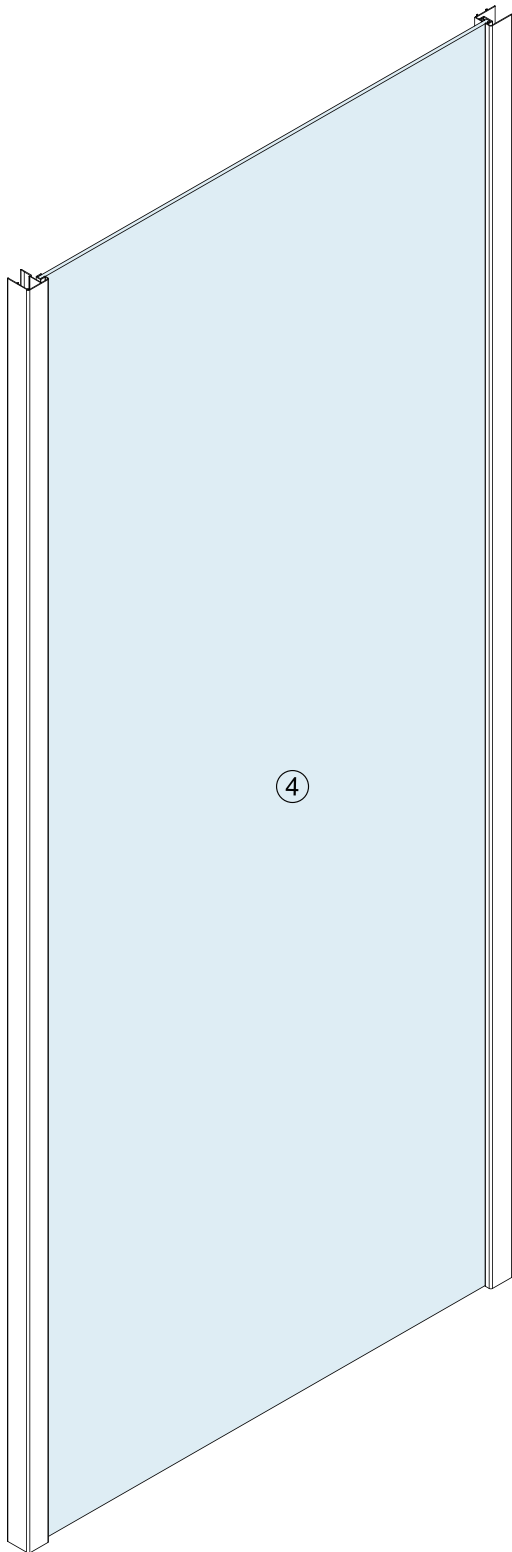

①



L=1950mm  
S-ILISPCS  
Cache vis Profilé aluminium x 1

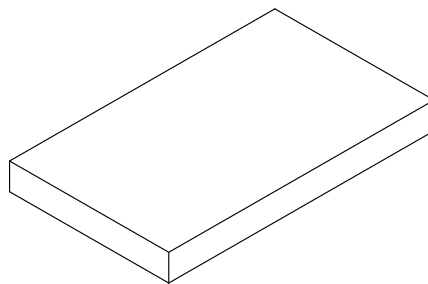

Boîte de composants

# COMPOSANTS ET OUTILS

LES ARTICLES QUE VOUS TROUVEREZ DANS LE KIT DE COMPOSANTS ET LES OUTILS NÉCESSAIRES À INSTALLER VOTRE PORTE DE DOUCHE ILI.



Dans la boîte

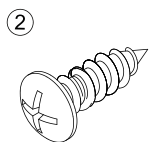

Vis ST4x10mm  
x3

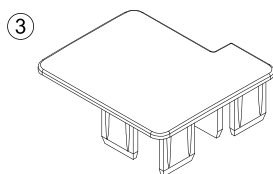

Cache Vis Profilé  
Mural Haut  
x1

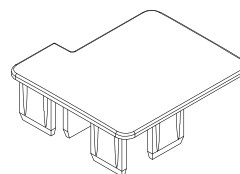

Cache Vis Profilé  
Mural Haut  
x1



Kit d'outils



Applicateur de  
silicone



Perceuse  
électrique



6mm Mèche  
perceuse



Marteau



Mesure de  
niveau



Mètre à ruban



Clé Allen



Tournevis



Poubelle

# PANNEAU LATÉRAL ILI

TOUTES LES PIÈCES PRÉSENTÉES CI-DESSOUS SONT NÉCESSAIRES POUR ASSEMBLER LE PRODUIT.

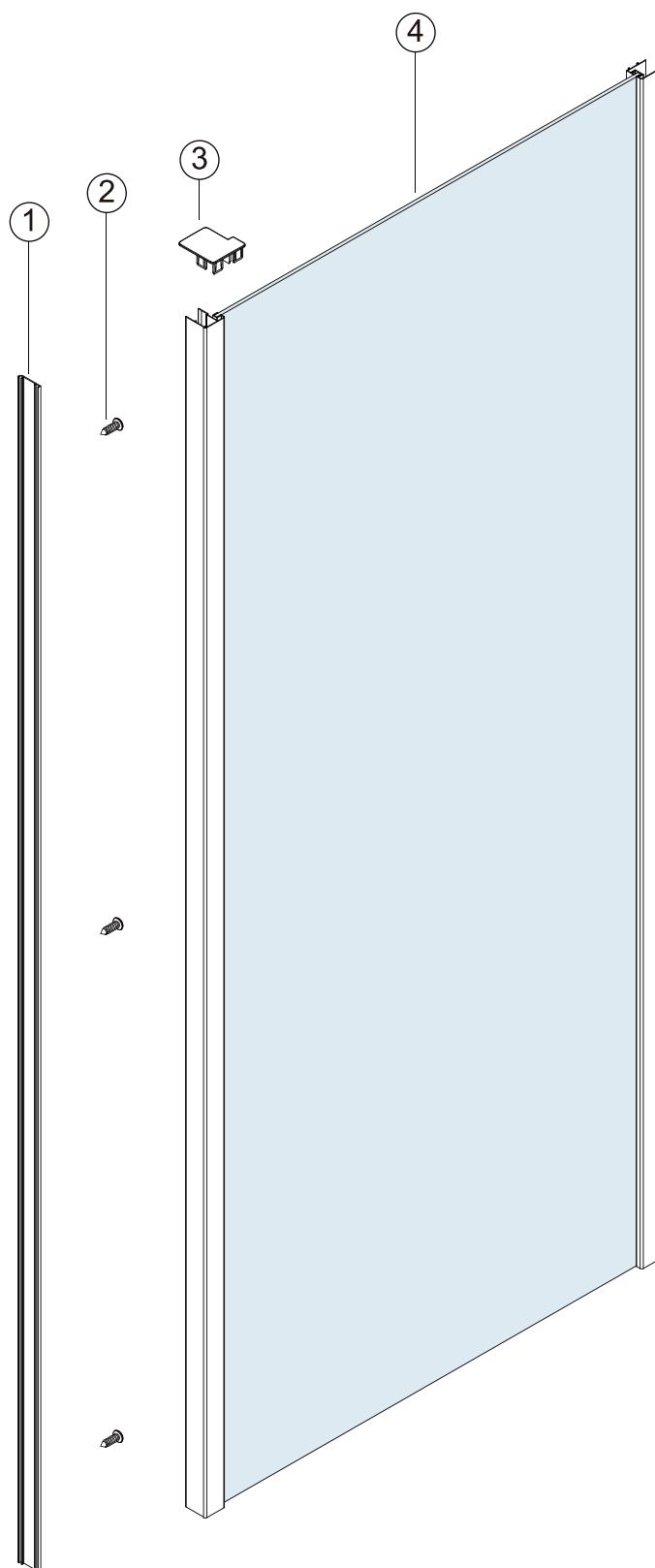

ARTICLE No.	QTE	Description	Pièce	ARTICLE No.	QTE	Description	Pièce
①	1	Cache vis Profilé aluminium	S-ILISPCS	③	2	Cache Vis Profilé Mural Haut	S-ILISPCPTC
②	3	Vis ST4x10mm	S-ILISPSP	④	1	Panneau latéral	A

The letters 'ILI' are rendered in a minimalist, sans-serif font. Each letter is composed of a solid red vertical bar. The 'I' is a single bar. The 'L' is formed by a vertical bar on the left and a horizontal bar extending to the right from its base. The second 'I' is a single bar.

**Vi ringraziamo per aver scelto la porta doccia ILI di Flair Showers Ltd.**

Siamo certi che nel suo utilizzo, ora e per molti anni a venire, avrete modo di apprezzarne la qualità artigianale e l'affidabilità.

Il bagno è lo spazio in cui inizia e termina la giornata - la porta doccia ILI renderà questi momenti più piacevoli.

ILI è il perfetto mix tra design e funzionalità - progettato per la vita.



---

## GARANZIA DI QUALITÀ

Flair si impegna costantemente per offrire prodotti di qualità.

I prodotti ILLI sono coperti da una garanzia a vita per difetti di fabbrica. La garanzia sarà valida a condizione che il prodotto venga installato e mantenuto nel rispetto delle istruzioni di montaggio di Flair e del buon senso.

Le parti soggette ad usura come le guarnizioni, i cuscinetti, etc. sono coperte da garanzia per 12 mesi dalla data d'acquisto.

Siete pregati di compilare il certificato di garanzia incluso nell'imballaggio o di registrare il vostro prodotto sul sito: [flairshowers.com/it/registrazione-della-garanzia-prodotto](http://flairshowers.com/it/registrazione-della-garanzia-prodotto).

Tutti i prodotti Flair sono conformi alla normativa CE/UKCA. Il vetro viene temperato e prodotto secondo le norme EN12150. Inoltre, tutti i prodotti sono testati e certificati EN14428, assicurandone i massimi standard qualitativi.

## SERVIZIO POST VENDITA

Flair si impegna nell'offrirti un eccellente servizio customer care.

Forniamo una gamma completa di pezzi di ricambio per ogni nostra collezione e mettiamo a disposizione specialisti post-vendita per assistervi con eventuali problemi.

Contatta il servizio clienti al +39 0287368301 oppure [assistenzaclienti@flairshowers.com](mailto:assistenzaclienti@flairshowers.com)

## AVVERTENZA!

**PRIMA DELL'INSTALLAZIONE  
LEGGERE ATTENTAMENTE LE  
ISTRUZIONI DI MONTAGGIO.  
LA MANCATA OSSERVANZA  
DELLE ISTRUZIONI POTREBBE  
INVALIDARE LA GARANZIA.**

Verificare che le misure del prodotto siano compatibili con quelle dell'area di installazione. Assicurarsi che il piatto doccia sia 100% in bolla. Controllare tutte le parti.

# CONTENUTO IMBALLAGGIO

TI PREGHIAMO DI CONTROLLARE IL CONTENUTO  
DI CIASCUNA SCATOLA

---

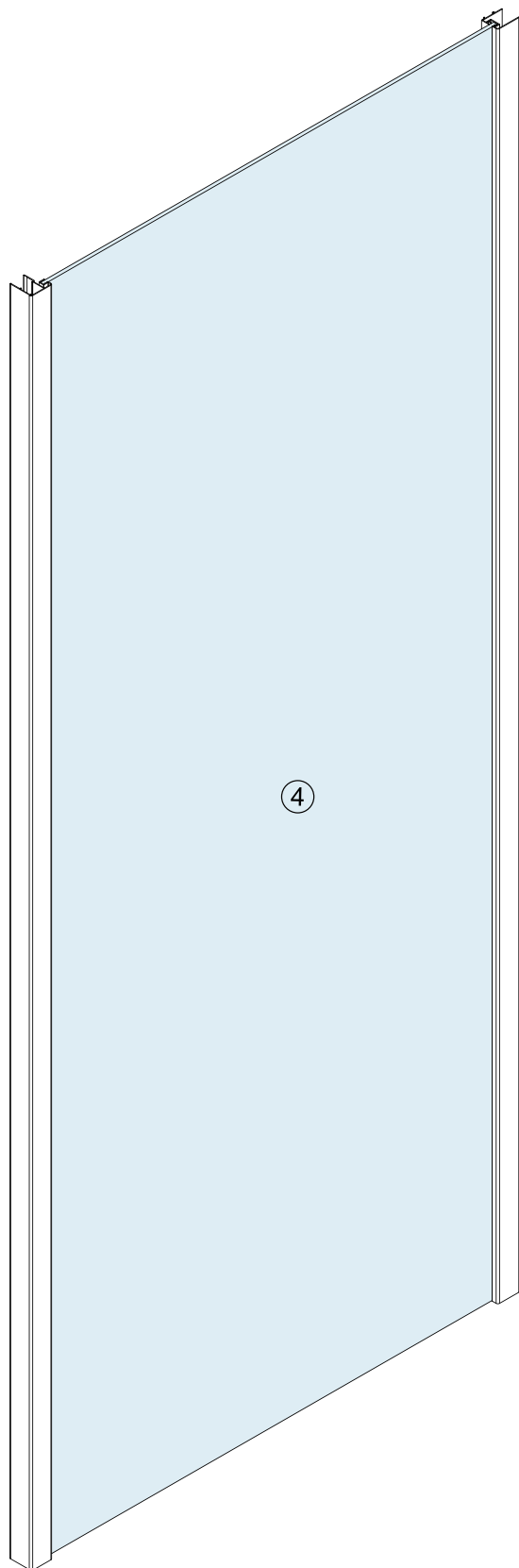

①



L=1950mm  
S-ILISPCS  
Copri viti x 1

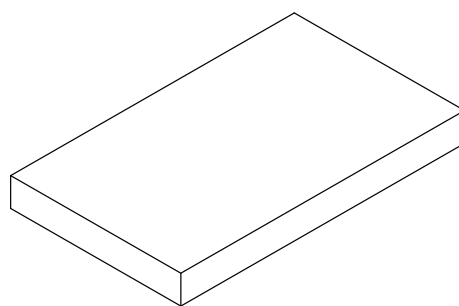

Kit di montaggio

# STRUMENTI PER L'INSTALLAZIONE

CONTENUTO DEL KIT DI MONTAGGIO E GLI STRUMENTI RICHIESTI



Nella scatola

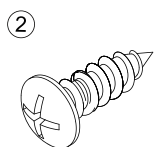

Viti 4x10mm  
x3

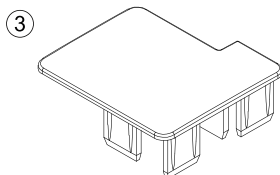

Tappo copri profilo  
a muro-sx  
x1

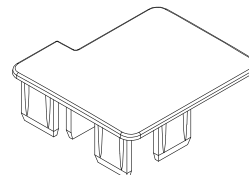

Tappo copri profilo  
a muro-dx  
x1



Strumenti



Pistola per  
silicone



Trapano



6mm Punta  
da trapano



Martello



Bolla



Metro a nastro



Brugola



Cacciavite



Cestino



# FLAIR PRESENTA LA PORTA A BATTENTE ILI

TUTTE LE COMPONENTI NECESSARIE PER L'ASSEMBLAGGIO

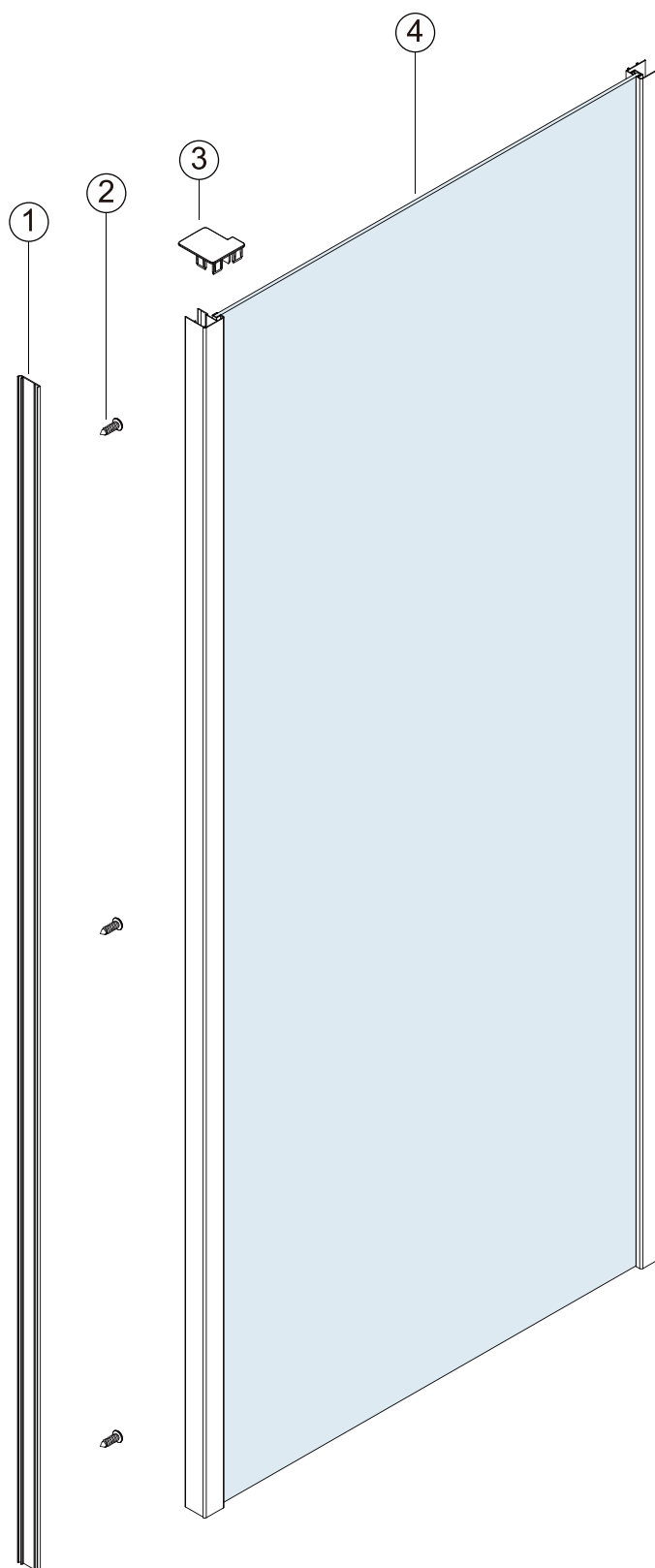

Nr Articolo	Qtà	Descrizione	Codice	Nr Articolo	Qtà	Descrizione	Codice
①	1	Copri Viti	S-ILISPCS	③	2	Tappo copri profilo a muro	S-ILISPCPTC
②	3	Viti 4x10mm	S-ILISPSP	④	1	Pannello fisso	A

1

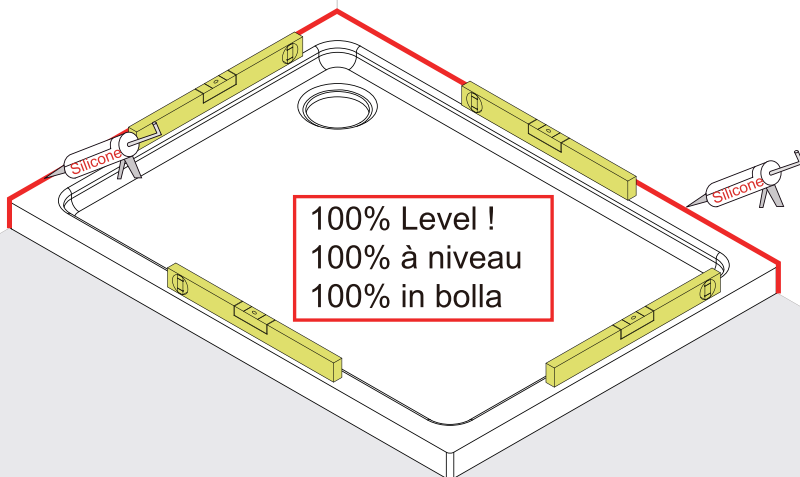
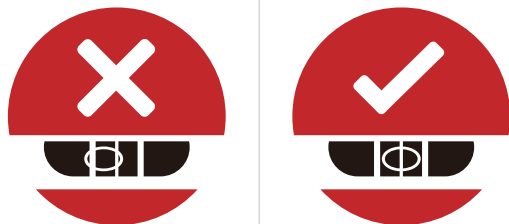

2

Size Taille Dimensione	X	Y
700	665-690	
760	725-750	
800	765-790	
900	865-890	
1000	965-990	950-975
1100		1050-1075
1200		1150-1175
1250		1200-1225
1300		1250-1275
1400		1350-1375
1500		1450-1475
1600		1550-1575
1700		1650-1675
1800		1750-1775

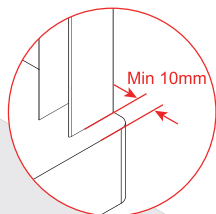
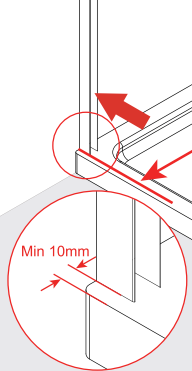
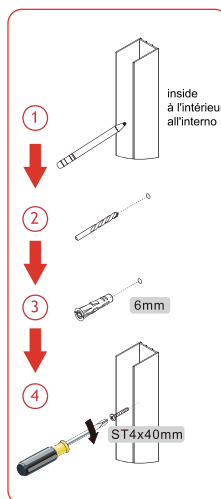

3

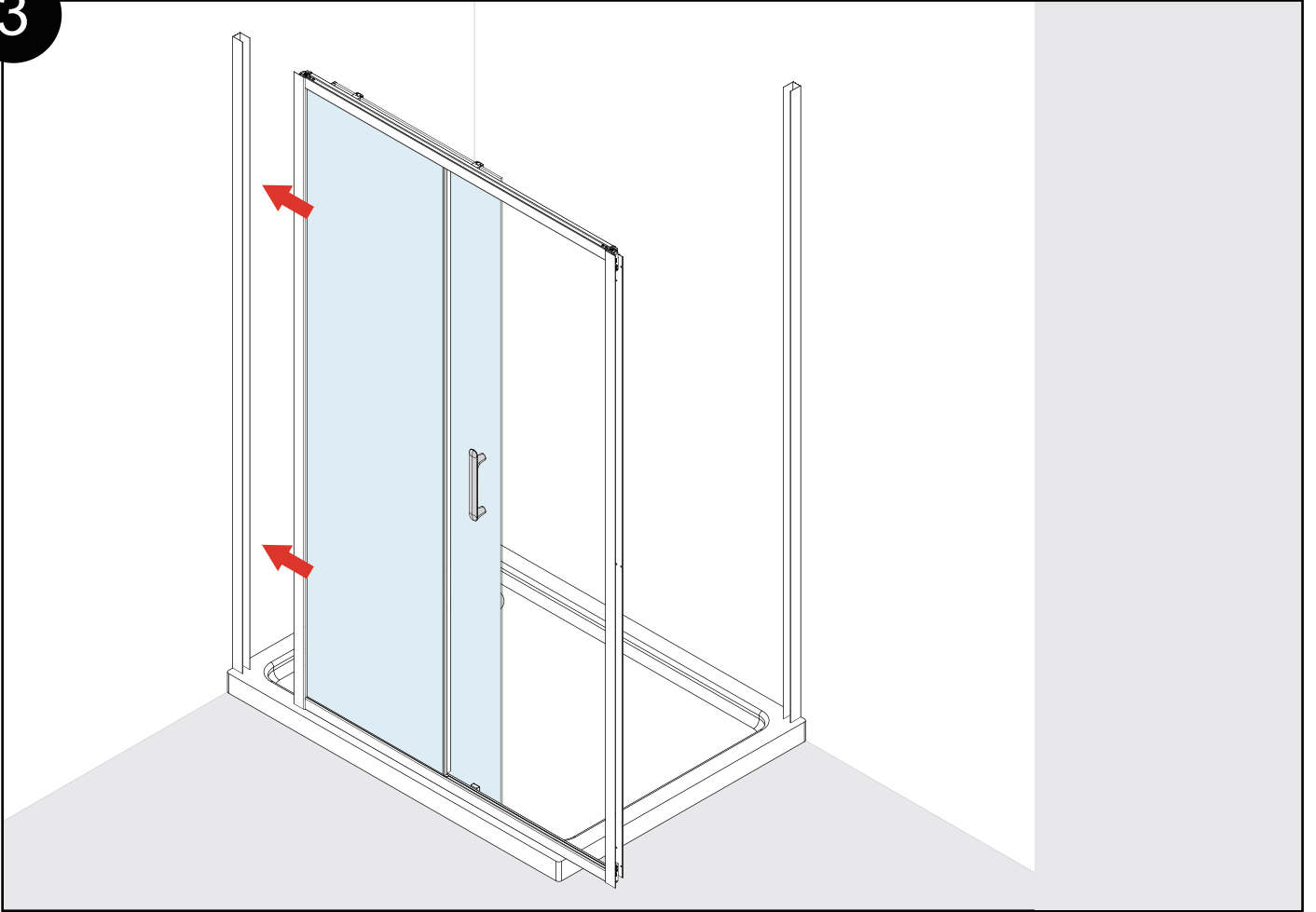

4

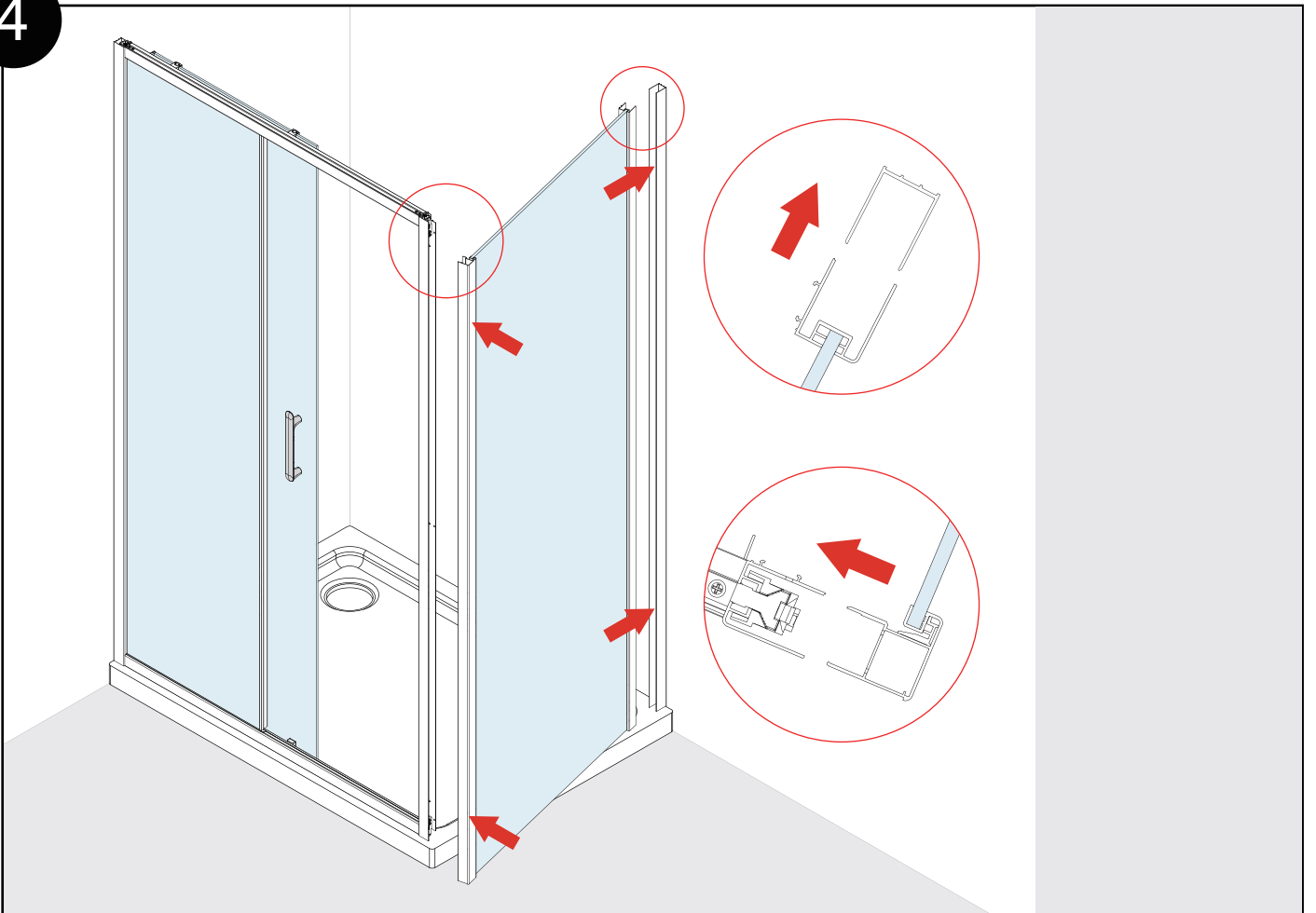

5

NB: Space profiles in wall jams equal distance from walls on each side.  
 NB: Placer les profilés de la porte dans les profilés muraux à égale distance des murs de chaque côté.  
 NB: Usa lo stesso spazio di regolazione nei profili per ciascun muro. (ES. 2 cm a sinistra e 2 cm a destra)

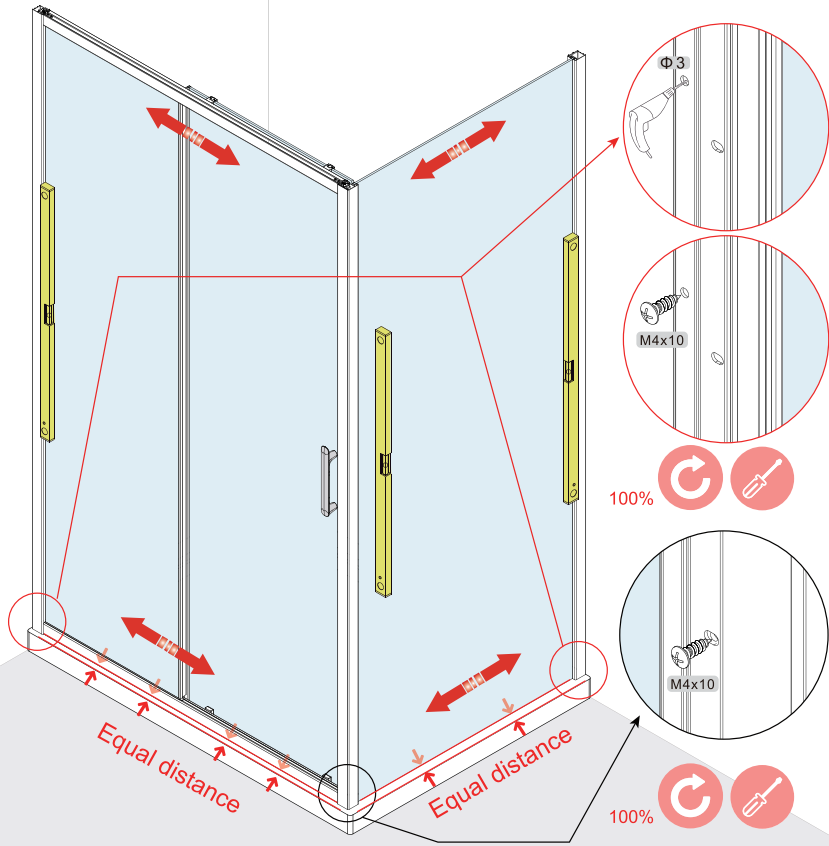

6

NB: Space profiles in wall jams equal distance from walls on each side.  
 NB: Placer les profilés de la porte dans les profilés muraux à égale distance des murs de chaque côté.  
 NB: Usa lo stesso spazio di regolazione nei profili per ciascun muro. (ES. 2 cm a sinistra e 2 cm a destra)

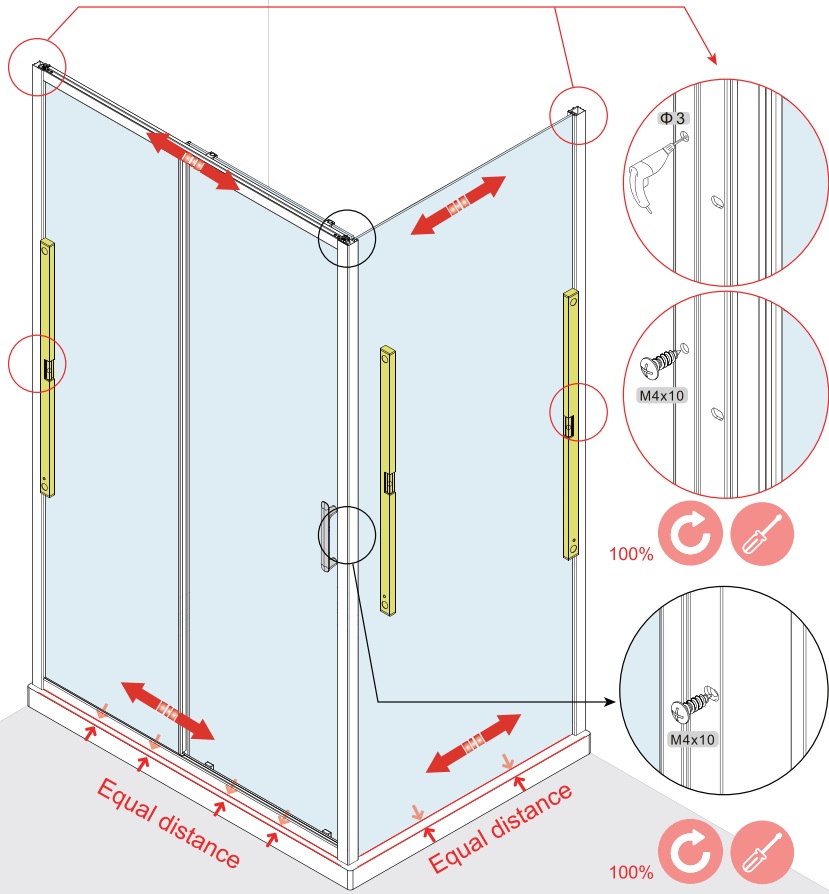

7

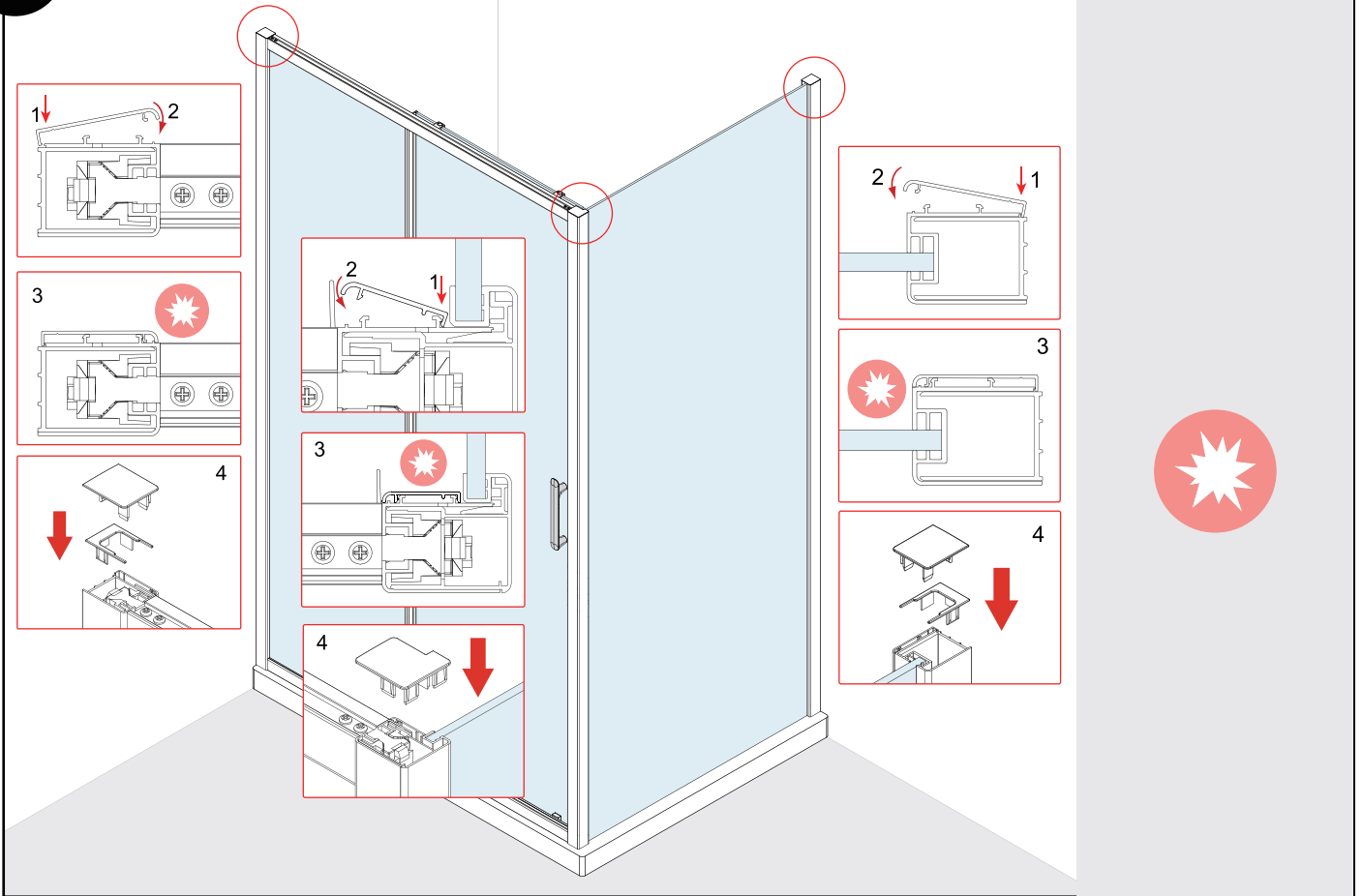

8

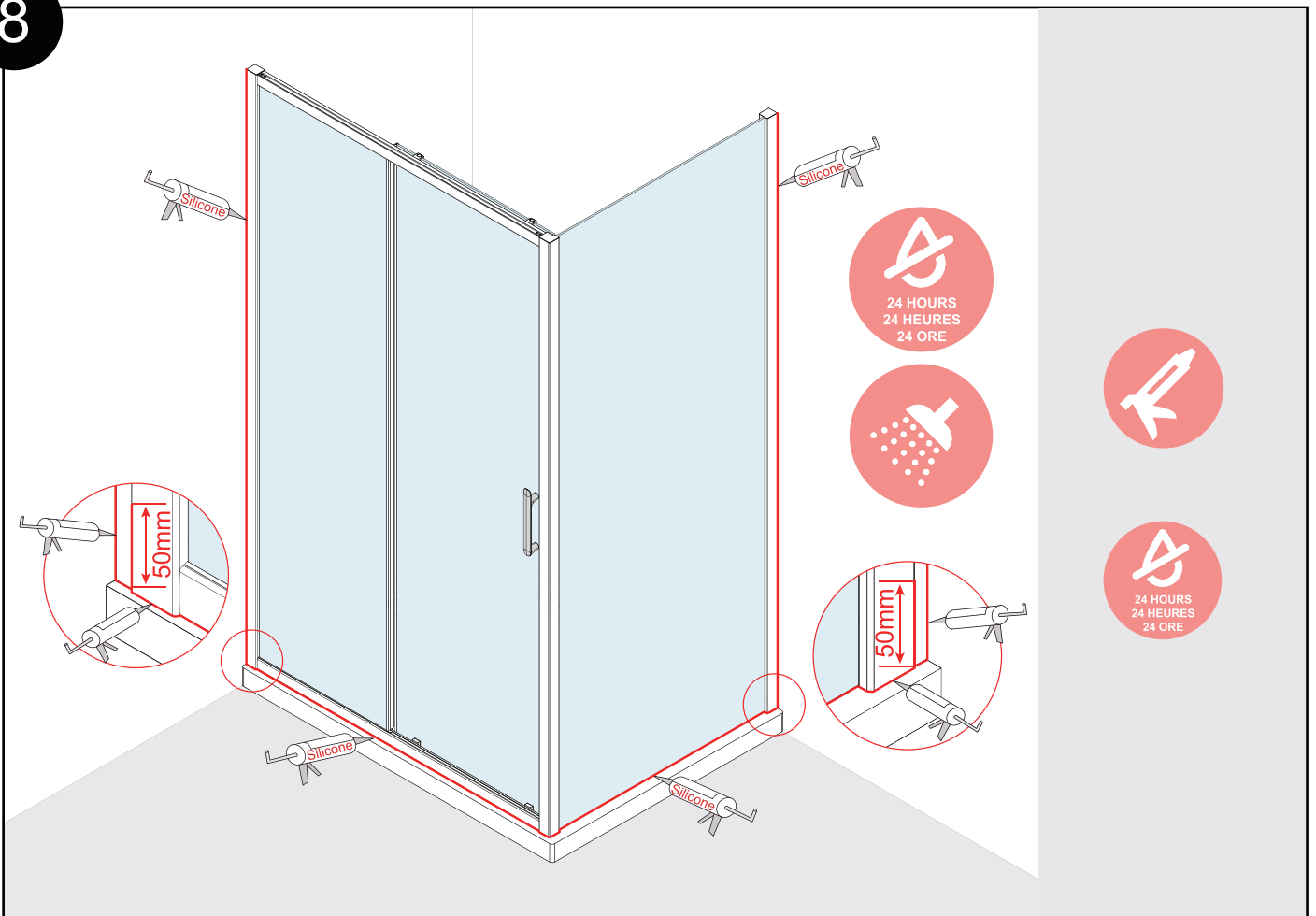

# INSTALLATION & MAINTENANCE

---

## INSTALLATION TIPS

It is the responsibility of the installer to ensure that the product is installed correctly and due care is given to the instructions.

**Your guarantee is invalid if the instructions have not been followed correctly.**

- Please check for all visual defects on the product before installation - such defects will not be accepted after installation of the product
- For shower enclosures a spirit level should be used to ensure your shower tray is level - if the shower tray is not level your shower door will not fit
- Ensure vertical wall profiles are level and are an equal distance in from the tray
- Ensure adjustment at wall profiles are equal at both sides and that all screws are fully tightened
- Ensure hinges are level and securely fitted to the glass
- Ensure magnets are the right orientation and are attracting rather than repelling
- Ensure silicone is used to waterproof your shower enclosure
- Care must be taken during assembly. Flair will not take responsibility where incorrect assembly results in undue stress being put on any of the glass components in this product
- If there are any manufacturing problems please call Flair Service Line on +353 42 966 8000

## CLEANING

ClearVue Glass coating is a standard feature on all ILLI shower doors. This easy to clean glass coating is applied to the glass surface and ensures that soap deposits and lime scale are easily cleaned off the glass.

**Glass:** Use a soft cloth and mild detergent, rinse off thoroughly\*

**Metallic Surfaces:** Use a soft cloth and warm soapy water\*

**Painted Surfaces:** Use a soft cloth & mild detergent, rinse off thoroughly\*

\*Do not use "Spray & leave" cleaning products on the metal surface as these will cause damage to your shower door. These include acidic based cleaning products, bleaches, solvents or abrasive pads. These will damage the anodising layer on the aluminium profiles.

\*In hard water areas, regular cleaning of your Flair door will help to prevent the buildup of limescale. Stubborn deposits of limescale can be removed with the use of a mild limescale remover.

\*Only use detergents, cleaners and limescale removers with a pH of 5-8.

\*The constant use of detergents will degrade the finish of the product over time if not thoroughly rinsed off.

## MAINTENANCE TIPS

- Check your shower door for functionality periodically
- Only use non-abrasive cleaning agents on all Flair products and rinse off thoroughly.
- Do not use excessive force when opening and closing your shower door as this could result in shattering
- Do not hang from your shower door or shower door handle - it is not designed to support excessive weight.

# INSTALLATION ET MAINTENANCE

## CONSEILS POUR L'INSTALLATION

Il est de la responsabilité de l'installateur d'assurer que le produit soit installé correctement en fonction des instructions de montage.

**Avant d'installer le produit, lisez attentivement toutes les instructions.**

**Si les instructions n'ont pas été correctement suivies votre garantie s'en trouvera annulée.**

- Veuillez vérifier que le produit ne comporte pas de défaut visible avant installation. Aucune réclamation ne sera acceptée une fois le produit installé.
- Vérifiez à l'aide d'un niveau que le receveur soit installé parfaitement à plat avant d'installer votre porte. Si le receveur n'est pas à niveau le montage de la porte ne sera pas possible.
- Positionner les profilés verticaux muraux à une distance égale du bord extérieur du receveur.
- Assurez-vous que les profilés muraux verticaux soient à niveau et droits et que toutes les vis soient bien serrées.
- Assurez-vous que les chamières soient à niveau et bien fixées sur le verre
- Assurez-vous que les aimants soient montés correctement et qu'ils s'attirent plutôt qu'ils se repoussent
- Sceller la porte de douche avec du silicone pour assurer l'étanchéité.
- Une attention particulière doit être prêtée lors de l'assemblage. Flair déclinera toute responsabilité si une mauvaise installation aboutit à des dégâts ou des pertes importantes.
- Attention : les panneaux en verre sont fragiles et sont donc à manipuler avec précautions.
- Pour tout défaut de fabrication, contactez nous au : + 353 42 96 94436.

## NETTOYAGE

Le traitement "ClearVue Glass" est une caractéristique standard de toutes les portes ILLI. Ce revêtement est appliqué sur la surface du verre et permet d'éliminer facilement les dépôts de savon et de calcaire.

- Verre : Utilisez un chiffon et un détergent doux, rincer abondamment.\*
- Surfaces métalliques: Utilisez un chiffon doux et de l'eau chaude savonneuse.\*
- Surfaces peintes : Utilisez un chiffon et un détergent doux, rincer abondamment.\*

\*Ne pas utiliser de produit sans rinçage sur les produits métalliques car cela risque de les endommager. Ces produits contiennent des ingrédients avec des bases acides, des décolorants, des solvants ou des gommages abrasifs qui peuvent endommager la couche d'anodisation sur les profilés en aluminium.

\*Dans les zones ayant une eau très calcaire, un nettoyage régulier de la porte de douche aidera à prévenir l'accumulation de dépôt calcaire. On peut enlever ces dépôts avec un détartrant doux.

\*Utilisez uniquement des produits de nettoyage avec un pH compris entre 5 et 8.

\*L'utilisation constante de détergents dégradera la finition du produit au cours du temps si le rinçage n'est pas effectué soigneusement.

## CONSEILS DE MAINTENANCE

- Vérifiez votre porte de douche pour la fonctionnalité périodiquement.
- Utilisez uniquement des produits de nettoyage non abrasifs sur toutes les portes de douche de Flair. Toujours rincer abondamment.
- Ne pas utiliser une force excessive pour ouvrir et fermer la porte, cela pourrait casser le verre.
- Évitez de vous suspendre sur les portes ILLI, elles ne sont pas conçues pour supporter des poids excessifs.

# INSTALLAZIONE E MANTENIMENTO

## CONSIGLI D'INSTALLAZIONE

È responsabilità dell'installatore assicurare che il prodotto venga montato correttamente nel rispetto delle istruzioni.

**La garanzia è invalida se il prodotto è stato installato non rispettando le istruzioni di montaggio.**

- Siete pregati di verificare che non ci siano difetti visibili prima di procedere con l'installazione. Ogni reclamo pervenuto ad installazione avvenuta non verrà accettato.
- Verificare che il piatto doccia sia perfettamente in bolla altrimenti la doccia non potrà essere installata.
- Assicurarsi che le pareti siano livellate e ci sia la stessa distanza dal piatto doccia.
- Assicurarsi che la regolazione nei profili sia uguale in entrambe le parti e che tutte le viti siano avvitate completamente.
- Assicurarsi che i cardini siano livellati e montati correttamente sul vetro.
- Verificare che i magneti siano nella direzione corretta, cioè si dovrebbero attrarre non il contrario.
- Usare silicone per assicurare la porta doccia contro le fuoriuscite d'acqua.
- Maneggiare con estrema cura durante l'installazione, Flair non accetta alcuna responsabilità in caso di rottura del vetro a causa di pressioni su di esso in questa fase.
- In caso di difetti di produzione contattati il +39 0287368301 oppure: [assistenzaclienti@flairshowers.com](mailto:assistenzaclienti@flairshowers.com)

## PULIZIA

Tutti i prodotti ILI hanno il trattamento anticalcare. Questo trattamento è applicato sulla superficie del vetro per rendere facile la pulizia di eventuali residui di sapone e del calcare.

Vetro:	utilizzare un panno e detersivi non corrosivi, infine risciacquare abbondantemente.*
Superfici metalliche:	utilizzare un panno e acqua tiepida con poco sapone.*
Superfici verniciate:	utilizzare un panno e detersivi non corrosivi, infine risciacquare abbondantemente.*

\*NON utilizzare prodotti che non richiedono il risciacquo sulle parti metalliche, perché si potrebbero danneggiare. Questo include l'uso di prodotti di pulizia aggressivi: candeggina, acidi, solventi o spugne abrasive. Questi danneggiano lo strato protettivo del profilo in alluminio.

\*Nelle aree con presenza di acque dure è consigliato pulire ed asciugare regolarmente le pareti doccia, al fine di evitare la deposizione di calcare. I depositi ostinati di calcare possono essere rimossi con l'uso di un anticalcare gentile.

\*UTILIZZARE SOLO DETERSIVI PER LA PULIZIA OPPURE ANTI-CALCARE CON PH 5-8.

\*L'utilizzo frequente di detersivi comporterà, nel tempo, la perdita della brillantezza dell'alluminio se non viene risciacquato abbondantemente.

## CONSIGLI PER IL MANTENIMENTO

- Verificare periodicamente la funzionalità delle porte doccia
- Utilizzare solo detergenti non abrasivi su tutti i prodotti Flair. Sempre risciacquare abbondantemente.
- Non effettuare troppa pressione nell'apertura o nella chiusura della porta in quanto questo potrebbe causare la rottura del vetro.
- Non appoggiarsi alla maniglia della porta doccia, questa non è stata disegnata per sostenere troppo peso.



# DESIGNED FOR LIFE

Flair Showers Ltd.  
Rocks Road  
Kingscourt  
Co Cavan  
Ireland

**T** +353 42 966 8000

**E** sales@flairshowers.com

ventes@flairshowers.com

(France+Benelux)

assistenzaclienti@flairshowers.com

(Italia + España)

Connect with us



FLAIRSHOWERS.COM